

English

North America

# AVANT<sup>®</sup>

## *220 225 225* LPG

### Operator's Manual 2016-



Read this Operator's Manual, safety decals, and other safety instructions before operating the loader. Failure to follow safety instructions can result in personal injury. Keep all manuals for further reference.

[www.avanttecnausa.com](http://www.avanttecnausa.com)

# TABLE OF CONTENTS

<b>INTRODUCTION</b> .....	<b>3</b>	Engine heater (option) .....	39
Foreword .....	3	Electric 12 V outlet.....	39
Make sure all relevant manuals are available.....	5	Seat - Seat belt and seat adjustments.....	40
Intended use .....	6	Seat heater .....	40
Warranty.....	8	Lights .....	41
<b>SAFETY FIRST</b> .....	<b>10</b>	CAB L (optional extra) .....	42
General safety instructions.....	10	<b>OPERATING INSTRUCTIONS</b> .....	<b>43</b>
Operation on uneven surfaces, gradients, and near excavations .....	13	Safe operating instructions label.....	44
Personal safety and protective equipment.....	13	Starting the engine .....	45
Electric system and handling the battery .....	15	Ignition key.....	45
Handling fuel (220/225) .....	16	Stopping the engine (Safe stopping procedure).....	46
LPG Fuel - Safety (225LPG).....	17	Drive control.....	48
Safety of LPG systems .....	17	In case the machine tips over.....	50
<b>DESCRIPTION OF THE LOADER</b> .....	<b>19</b>	Material handling.....	51
Identification of the loader .....	19	Refuelling (220/225).....	52
Main parts of the loader .....	20	Replacing a gas bottle (225LPG).....	53
Signs and decals .....	21	Transporting instructions and tie down points .....	54
Technical specifications .....	27	Storage .....	55
General specifications .....	28	<b>WORKING WITH ATTACHMENTS</b> .....	<b>57</b>
Tyres.....	29	Requirements for attachments .....	57
Wheel spacers .....	29	Coupling the attachments .....	58
Wheel weights (optional extra) .....	29	Coupling the hydraulic hoses of the attachment .....	60
Fuel requirements.....	30	Using the auxiliary hydraulics.....	61
Engine oil requirements.....	31	Releasing the residual pressure of hydraulic systems .....	62
Auxiliary hydraulics oil flow .....	31	<b>SERVICE AND MAINTENANCE</b> .....	<b>63</b>
Tipping load .....	32	Installing of service support and frame lock.....	65
<b>CONTROLS OF THE LOADER</b> .....	<b>34</b>	Daily inspections.....	66
Parking brake lever .....	34	Maintenance schedule .....	67
Dashboard.....	35	Loader maintenance .....	68
Indicator lights .....	35	Engine maintenance .....	73
Control of loader boom, auxiliary hydraulics and other functions .....	36	Engine service.....	73
Engine compartment .....	38	Fuel system, gasoline 220/225.....	76
Battery disconnect switch.....	38	Fuel system, 225LPG .....	77
Trailer coupling.....	38	Jump start and auxiliary power .....	79
Rear auxiliary hydraulics outlet (option).....	39	<b>TROUBLESHOOT</b> .....	<b>80</b>
		<b>SERVICES MADE</b> .....	<b>82</b>
		<b>INDEX</b> .....	<b>86</b>

# Introduction

## Foreword

AVANT TECNO OY wants to thank you for purchasing this AVANT loader. It is the result of Avant's long experience in design and manufacturing of compact loaders. We ask you that you read and understand the contents of this manual completely before operating the loader. This operator's manual is intended to help you to:

- operate this machine safely and efficiently
- observe and prevent situations that may cause a risk of physical injury or danger
- keep the machine in good condition and its life span as long as possible

The following warning symbols and signal words are used throughout this manual to indicate factors that must be taken into account to reduce the risk of personal injury or damage to property:

	<b>WARNING:</b> <b>SAFETY ALERT SYMBOL</b>
	This symbol means: <b>“Warning, be alert! Your safety is involved!”</b> Carefully read the message that follows, it warns of an immediate hazard that could cause serious personal injury. The safety alert symbol by itself and with related safety statement indicates important safety messages throughout this Manual. It is used to draw attention to instructions involving your personal safety or the safety of others. When you see this symbol, be alert, your safety is involved, carefully read the message that follows, and inform other operators.

 This signal word indicates a hazardous situation which, if not avoided, will cause death or serious injury.  
On decals the background of the signal word is red.

 This signal word indicates a potentially hazardous situation which, if not avoided, could cause serious injury or death.  
On decals the background of the signal word is orange.

 This signal word is used when minor injury could result if the instructions are not followed properly.  
On decals the background of the signal word is yellow.

**NOTICE**

This signal word indicates information about the correct operation and maintenance of the equipment. It is used without the safety alert symbol.

Failure to observe the instructions accompanying the symbol can lead to equipment breakdown or other property damage.

On decals the background of the signal word is blue.

**SAFETY INSTRUCTIONS**

Labels with a green heading box indicate that the the accompanying message shows specific safety-related instructions or procedures. The heading text will reflect the message in the label.

## **Terms used in this manual**

Main parts of the loader are shown on page 20.

Units used in this manual are metric system units, unless stated otherwise. All dimensions without an unit are *millimetre*.

Left / Right **Left** and **right** side are defined as seen from the driver's seat.

Attachment Interchangeable equipment, mounted on the quick coupling plate on the loader boom. Additional coupling procedures may be required as shown in the operator's manual of each attachment.

Most attachments, unless specifically stated otherwise, are controlled from the driver's seat using the controls of the loader.

Lifting equipment Any device mounted on the loader intended to lift loads or to serve as a tying point for chains, lifts, or hooks are lifting equipment. All lifting equipment must be approved for the intended capacity and checked periodically by an expert.

## **This manual is available in other languages as well**

This manual, all warning labels, as well as attachment operator's manuals, are available in other languages as well.

Contact your Avant dealer for a copy of instructions in needed language to make sure all operator's can understand the instructions.

Below are reminders in Spanish and French.

**AVISO**

Este manual, todas las etiquetas de advertencias, así como los manuales del usuario adjuntos están disponibles en español.

Póngase en contacto con su distribuidor para obtener una copia de las instrucciones en español.

**REMARQUE**

Ce manuel, toutes ses étiquettes d'avertissement, de même que les manuels de l'opérateur de l'accessoire sont disponibles en français.

Contactez votre concessionnaire pour obtenir une copie des instructions en français.

**Make sure all relevant manuals are available**



Wrong use of the equipment can cause death or severe injuries - Make sure to read all relevant manuals and instructions thoroughly and keep them available for all operators.



Using each attachment requires specific information about correct use, mounting procedure, safety, and how to avoid hazardous situations. An attachment may introduce risks that are not present when operating the loader with other kinds of attachments. Always read the operator's manual of each attachment carefully.

**Manuals of attachments**



Attachments can create significant risks that are not covered by this Operator's manual of the loader.

Make sure you have all attachments manual available. Wrong use of an attachment can cause serious injuries or death.

Each attachment is accompanied by its own respective Operator's Manual. The manual will show important information related to safety, and how to attach, use, and maintain each attachment correctly.

**Engine manual**

**KOHLER Command PRO**  
ECH630-ECH749, CH735/CH26, CH745  
ECV630-ECV749, CV735, CV745  
Owner's Manual

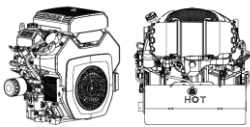

**IMPORTANT:** Read all safety precautions and instructions carefully before operating equipment. Refer to operating instruction of equipment that this engine powers.  
Ensure engine is stopped and level before performing any maintenance or service.  
Warranty coverage as outlined in the warranty card and on KohlerEngines.com. Please review carefully as it provides you specific rights and obligations.  
To maintain compliance with applicable emission regulations, exhaust system backpressure may not exceed limits which can be found on KohlerEngines.com. Search by Model No., select Read More, then select Select List.

Please engine information to reference when ordering parts or obtaining warranty coverage.

Original Model: \_\_\_\_\_  
Specification: \_\_\_\_\_  
Serial Number: \_\_\_\_\_  
Purchase Date: \_\_\_\_\_

24 990 02 Rev. D KohlerEngines.com

In addition to this Operator's manual of the loader, ensure that you have received and read also the original Engine owner's manual.

The instructions concerning the engine must be followed. If conflicting information is found, the information shown in the Operator's Manual of the loader must be followed.

**Spare parts list**



All spare parts of the loader are listed in a separate spare parts list. Engine related parts are listed in the spare parts list of the engine.

## **Intended use**

Avant 220/225/225LPG are articulated compact loaders, designed and manufactured for both private and professional use. The loader can be equipped with attachments offered by Avant Tecno Oy, which enables performing several different jobs. Because of this multi-purpose nature of the machine and the various attachments and tasks, read always not only this Manual but also the Operator's Manual of the attachment, and follow all instructions. Every person who has to do with this machine must follow work safety regulations, all other generally accepted rules related to work health and safety, and all road traffic regulations.

Remember that safety consists of several factors. The loader, equipped with an attachment is very powerful and can cause serious personal injuries or property damages if it is operated in a wrong or careless way. Do not operate an attachment unless you have familiarised yourself with the use of it and the eventual dangers related to it. The loader is not intended to lift or transport people or be used as a work platform. Different jobs require different attachments, and it is not allowed to handle loads without any attachment fitted. The loader must not be used in underground or tunneling work.

Contact your local AVANT dealer, if you are uncertain of anything concerning the operation and maintenance of this loader, or for any questions, service or spare parts.

In addition to the safety instructions included in this manual, you must observe all occupational safety regulations, local laws, and other regulations concerning the use of the equipment. Particularly the regulations concerning the use of the equipment on public road areas must be observed. Contact your Avant dealer for more information about local requirements before you operate the loader on road areas. The use of LPG equipment on road areas may be restricted or regulated.

This loader has been designed to require as little maintenance as possible. The operator can perform the routine maintenance tasks. There are however more demanding service operations that must be done by professional service personnel only. It is allowed to perform service operations only when wearing appropriate protective equipment. Original spare parts must be used. Familiarise yourself with the service and maintenance instructions in this Manual. Operating a loader that is in poor condition, or that has received unauthorised modifications, can be hazardous to the operator and bystanders.

### ***Gas operated 225LPG***

The gas evaporation capability of the LPG cylinder limits the lowest operating temperature. Engine performance may decrease significantly at temperatures below 0°C (32°F) and engine may not run. Even though the LPG engine runs cleaner and produces less harmful emissions than gasoline engines, it is not intended or suitable to be used in enclosed spaces or areas with poor ventilation. See warnings in this manual.

The gasoline and LPG engines have fundamental differences between each other. In addition to fuel delivery system differences include engine valves and other major parts. The gasoline engine of the 225 cannot be converted to LPG engine. Any attempt to modify the engine can cause risk of fire, poor performance, short service life, and will void all warranties.

## **Operator qualification**

Only operators who have studied this manual, and all relevant attachment manuals, are allowed to use this loader. Regardless of your possible previous experience with lawn-mowers, loaders, ATVs, or other equipment, it is important that you learn the driving principle of this loader. Practise how to operate the loader and its attachments safely at an open area before you use the loader near other persons.

You must be in good physical and mental condition with the ability to stay alert and to observe the surrounding area. Never use the equipment while under influence of medication which could impair your abilities to operate the equipment safely. Do not operate the loader if you are under the influence of alcohol or any other intoxicant during the work shift.

Depending on operating area, you may also be required to read, understand and comply with all applicable Employer, Industry and Governmental rules, standards and regulations.

You can replace an empty gas bottle with a full one by yourself with the instructions shown in this manual. Any other gas related service or repair, such as replacing a hose or a fitting, must be left to qualified service personnel. Gas related service tasks may require a registered professional.

## **Versions of this manual**

Avant has a policy on continuous product development. Updated versions of the manual replace the previous versions of this manual as long as the year on the cover page matches with the original manual. You can ask for the latest manual from your dealer. Some of the features or technical details presented in this manual may change without notice. The pictures in this manual may show optional equipment or features that are not currently available in your market area. We reserve the right to change the contents of the manual without notification.



Keep this Operators Manual with the machine at all times. If this Manual gets lost, ask for a new copy from your Avant dealer. Remember also to give this Manual to the new owner when the machine changes ownership.

## Warranty

### Limited Product Warranty on Avant 220/225 Series Loaders (United States and Canada Only)

Scope of Warranty: Avant Tecno USA, INC., (hereinafter referred to as, "Avant"), warrants for a period of <WarrantyYears> years or <WarrantyHours> hours of use, whichever occurs first, commencing on the original date of purchase from Avant or an authorized Avant dealer (the "Warranty Period") that its Avant 220/225 series loaders (the "Products") will be free from all defects in material and workmanship (the "Limited Warranty").

The foregoing Limited Warranty provided by Avant is the only warranty provided by Avant with respect to the Products, and may be modified or amended only by a written instrument signed by an authorized representative of Avant. Without limiting the foregoing, all tools, equipment and accessories furnished by third parties (including, without limitation, the engine and other component parts) are warranted only to the extent of the original manufacturer's warranty to Avant and then only to the extent that such original manufacturer's warranty is assignable by Avant to its customer. Any tools, equipment, or accessories (aside from the Products) furnished by Avant may be covered by a separate warranty under the terms thereof, where applicable, and shall not be covered by this Limited Warranty.

**Exclusions:** The foregoing Limited Warranty shall not apply to Products that have been subject to improper use, installation or maintenance, abuse, neglect or accident, or to circumstances beyond Avant's control, including, without limitation:

1. Products that have not received regular maintenance in accordance with Avant's specifications or instructions;
2. Damage or defects due to customer's failure to follow Avant's directions, ordinary wear and tear, alteration, negligence, or accident
3. Damage to the Products caused by the use of incorrect fuel, hydraulic or engine oil, lubricants, cooling liquid or cleaning solvents; and
4. Damage to the Products resulting from the use of attachments or maintenance parts that are not approved by Avant or suitable for use with the Products.

The foregoing Limited Warranty shall also not apply to any consumable parts on the Products (e.g. tires, batteries, filters, belts, etc.) (collectively, "Parts") except in the limited circumstance where it can be shown that the Parts were defective at the time of purchase. Avant shall have no responsibility whatsoever for any breach of warranty on the part of any other manufacturer. Under no circumstances shall Avant be liable for any repairs or other claims if alterations have been made to the Products by the customer or others without Avant's prior written consent.

**No Other Warranties:** Avant makes no other warranties of any kind, express or implied, with respect to its Products. All implied warranties of merchantability, fitness for a particular purpose or otherwise which exceed the obligations and warranty period stated in this limited warranty are hereby disclaimed and excluded from this limited warranty.

**Limitation of Liability:** Avant's aggregate liability in connection with the sale of its Products, regardless of the form of action giving rise to such liability (whether in contract, tort or otherwise), shall not exceed the aggregate purchase price paid by the customer to Avant for the Products. IN NO EVENT SHALL AVANT BE LIABLE FOR ANY EXTRAORDINARY, EXEMPLARY, SPECIAL, INDIRECT, CONSEQUENTIAL OR INCIDENTAL DAMAGES OF ANY KIND, INCLUDING, WITHOUT LIMITATION, LOST PROFITS OR LOSS OF USE, EVEN IF AVANT HAS BEEN ADVISED OF THE POSSIBILITY OF SUCH DAMAGES.

*Continued on following page*



*Warranty, continued from previous page*

**Customer's Responsibility:** To make a warranty claim hereunder, customer must notify Avant in writing and return the Products to an Avant authorised dealer, as instructed by Avant, within the Warranty Period. To ensure the validity of any warranty claim, the serial number on the Products must be legible and the customer shall be required to provide the date of purchase. Customers should contact the Avant dealer from whom it purchased the Products, or contact Avant USA directly at the address below:

Avant Tecno USA Inc.

3020 Malmo Drive

Arlington Heights, IL 60005

Phone: 847-380-9822

Customer shall be responsible for all shipping and handling costs in connection with returning Products for repair or replacement.

**Limitation of Remedies:** In the event a Product is found to be non-conforming with the Limited Warranty set forth herein during the Warranty Period, Avant will, at its option, either repair the same or supply a replacement thereof. THE FOREGOING STATES THE ENTIRE LIABILITY AND OBLIGATIONS OF AVANT WITH REGARD TO THE SALE OF ITS PRODUCTS.

# Safety First



Incorrect or careless operation of the loader may cause a serious accident. Before putting the machine into operation, familiarise yourself with the use of the machine and read and understand this Operator's Manual, as well as all relevant safety instructions, local regulations, and safe working practices.

## **⚠ DANGER**

Understand the limitations of speed, braking, steering and stability as well as loading capacity of the machine before starting operation. Make sure that everyone who operates or works with this equipment is familiar with these safety precautions.

If you have no previous experience of the machine, make sure to do all testing at a safe and open place with no persons in the area of operation.



Read this Operators Manual, and also the Operators Manual of the attachment(s), the engine owner's manual, safety decals and other safety instructions before beginning to operate the loader. Failure to follow the safety precautions listed in this manual may result in personal injury and/or damage to the equipment.

## General safety instructions

1. Remember the correct working position. When driving, be comfortably seated in the driver's seat, keep your feet in their proper place in the footwell and at least one hand on the steering wheel.
2. When seated, always keep the seat belt fastened and keep hands and feet inside the operator's area.
3. Before leaving driver's seat, always:
  - Lower the loader boom and place attachment flat on ground
  - Engage the parking brake
  - Stop the engine, remove the ignition key
4. Start the operation slowly and carefully. Practise driving of the machine at a safe and open place before connecting any attachment, and follow the instructions in this Manual and also the operator's manual of the attachment.
5. Operate the control levers with careful and deliberate movements. Avoid abrupt movements when handling the load, in order to prevent the load from falling and to keep the machine stable.
6. Keep away from the danger zone of the lifted boom and don't let anyone go there.
7. Keep your hands, feet and clothing away from all moving parts, hydraulic components, and hot surfaces.
8. Make sure that there is enough open space around the machine for safe driving.
9. Do not transport the load with the boom lifted. Always carry bucket or attachment as low as possible, and put the load down whenever you leave the machine.
10. It is not allowed to transport persons with this machine. Do not transport or lift persons in the bucket or in any other attachment.
11. Do not exceed the tipping load. Familiarise yourself with and follow the load diagrams in this Manual.
12. When turning with the machine, remember that the driver's seat extends beyond the turning radius of the wheels (collision risk).
13. Do not operate the loader in an explosive environment or in a place where dust or/and gases can create a fire or explosion hazard.

14. Keep the engine area clean of flammable materials.
15. Read the lifting, towing and transportation instructions on page 54.
16. Switch off the battery disconnect switch whenever leaving the machine unattended.
17. Follow all inspection, service and maintenance instructions. If you notice any faults or damages on the machine, these must be repaired before starting operation.
18. Before any maintenance or repair operation always stop the engine, lower the boom down and release pressure from hydraulic system. Read safety instructions for maintenance on page 63.
19. Do not let any person operate this loader who has not read safety instructions and is not familiar with the safe and correct use of this loader.
20. Never operate the loader or attachments while under the influence of alcohol, drugs, medication that may impair judgement or cause drowsiness, or if not otherwise medically fit to operate the equipment.

### Suffocation hazard - Ensure ventilation



Engine exhaust contains carbon monoxide (CO), a poison gas you cannot see or smell. Using a loader in enclosed space or poorly ventilated areas will kill you in minutes.

**Never operate the loader indoors or in partly enclosed areas** unless you've made sure there is special ventilation system installed. Even LPG engines are not safe to operate in enclosed or poorly ventilated indoor areas. They produce carbon dioxide (CO<sub>2</sub>) and can also emit carbon monoxide (CO) under some conditions that can concentrate quickly to a dangerous level. **Never leave the engine running in garages or sheds.** Operate the loader only outdoors and far from windows, doors, and vents.

Elevated level of carbon dioxide or carbon monoxide in breathing air can not be noticed without dedicated measuring equipment. Signs of carbon monoxide poisoning include nausea, headache, dizziness, drowsiness, and lack of consciousness.

Get fresh air if anyone shows signs of carbon monoxide poisoning and see a doctor.

### Articulated frame - Risk of overturning



Turning articulated frame can lead to overturning of the loader on inclined terrain or when driving at high speed. Never turn frame towards the slope while operating on inclined ground.

Always drive slowly when carrying load or when turning with the machine.

### Sudden movements can tip the machine over - Risk of overturning



Movements, such as stopping, turning, or lowering the boom abruptly, can cause loss of stability. Always drive slowly and operate the controls of the loader very carefully, especially when handling heavy loads.

### Overload - Risk of overturning

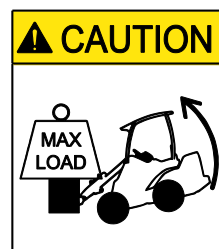

The high lift capacity of the loader makes it possible to exceed the stability of the loader when handling loads. Read the instructions regarding maximum lift capacity and load handling in this Operator's Manual. Following the instructions reduces the risk of tipping the machine over its front axle, but the operator must be aware of the limits of the machine and follow safe working practises to avoid overturning of the machine.

**⚠ WARNING**

Never take a heavy load on the loader from high level – e.g. from truck, shelf etc. – risk of tipping over!

If the load is too heavy when lifting load from a high level, the loader could tip forward when reversing with the loader.

Never reverse and drag with the loader before you make sure that the loader can handle the load that is being lifted.

When loading, always keep the loader frame as straight as possible.

**Falling of persons - Risk of crushing**

Never use the loader or its attachments to lift persons or as any kind of work platform even temporarily. Never climb on the loader or on the attachment. Seating capacity: one person only.

**Falling of load or unexpected lowering of loader boom - Risk of crushing**

Always remember that the boom may lower unexpectedly due to loss of stability, mechanical fault, or if another person operates the controls of the loader, leading to crushing hazard. The attachment or the loader are not intended to be left to keep a load elevated for longer periods. Lower the attachment before leaving the driver's seat. The stability of the loader may change when leaving the driver's seat, leading to tipping over of the machine.

**Risk of falling objects**

Make sure load is securely on the attachment. Never tilt the attachment back when it is lifted high. Operate only with machines equipped with ROPS and FOPS structures.

## Operation on uneven surfaces, gradients, and near excavations

Extra caution is needed when using the equipment on inclined terrains and slopes. Drive slowly especially on inclined, uneven, or slippery surfaces, and avoid sudden changes in speed or direction. Operate the controls of the loader with careful and smooth movements. Watch out for ditches, holes on the ground, and other obstacles, as hitting an obstacle may cause the loader to tip over.

### ***Overturning of machine can lead to death or serious injury***



The stability and the load handling capacity of the loader are significantly reduced on inclined terrains and maximum lifting capacity can be achieved only on firm, level ground. On horizontally tilted terrain the load must be kept close to the ground and must never be lifted high.

- Handle heavy loads only on even surfaces.
- Drive very slowly on uneven terrains. Load, unload, and turn the machine on flat level ground only. Lifting a load or turning on uneven surfaces can lead to loss of stability.
- Do not drive on too steep a gradient - watch out for ditches, manholes and steep gradients, which may cause the loader to tip over.
- Never drive along an excavation. Note that the excavation or trench may suddenly cave in. Exercise extreme caution when driving near ditches or embankments, and avoid driving along a ditch or trench, as the machine could suddenly tip over if an edge caves in. Avoid driving along trenches and keep at least a distance equal to width of a trench.
- Do not park the machine on a surface with a gradient. Should this be necessary, engage the parking brake and preferably turn the machine sideways and put down the load. If needed, use chocks behind the wheels.

## Personal safety and protective equipment

Wear safe clothing and personal protective equipment.

- Protect yourself against work hazards like noise, ejecting debris or dust for example.
- Follow regulations regarding protective equipment. Wear eye protection and hard hat or other protective equipment as needed.
- Read Operator's Manual of the attachment for more information about protective equipment needed in the work.



- The noise level at the driver's seat may exceed 85 dB(A). Wear hearing protection while working with the loader.



- Wear protective gloves.



- Wear safety boots whenever working with the loader.



- Wear safety glasses when handling hydraulic components.



- Always fasten seat belt while operating the machine.



- When working at construction sites, a safety helmet is recommended and may be mandatory in addition to the falling objects protective structure (FOPS) on the loader.



- Depending on work and working area, also a respirator mask may be required. Find out about other necessary safety equipment at your specific work site.



**Silica dust warning.** Prolonged exposure to crystalline silica can cause a lung disease called silicosis. Occupational health and safety officials recommend limiting exposure to dust that is present at most earth-moving and many other work sites. Avoid spreading of dust where possible, keep loader cabin clean from dust, use respiration mask when necessary.

**Safety frame (ROPS) and safety canopy (FOPS)**

The loader is equipped with a Rolling Over Protective Structure (ROPS) and a Falling Object Protective structure (FOPS). These safety structures are important parts of operator safety, and they must be fitted on the machine.

Safety frame (ROPS) protects the operator in case the machine tips over. Fasten seat belt while operating a machine with a ROPS. All cab versions are ROPS & FOPS tested and certified.

***Crushing hazard - Always keep safety structures installed***



Never take off the safety structures, modify them, or attempt to repair. If damaged, contact service.



Always fasten the seat belt in order to stay inside the protected area of the safety frame.

**Modifications**

Any modification to this machine must be approved beforehand by an authorised Avant representative. If you modify the loader or attachment, it can become dangerous and cause serious injuries or even death. Unauthorised modifications can increase the risk of accidents and damage or shorten the service life of the machine. Modifications to engine can make it no longer compliant with emission regulations. Use only original spare parts to make sure that the product is kept in safe operating condition.

<b>⚠ WARNING</b>	<p><b>California Proposition 65 Warning</b></p> <p><b>Exhaust fumes</b></p>
<p>The engine exhaust of this product contains chemicals known to the State of California to cause cancer, birth defects or other reproductive harm.</p>	

<b>⚠ WARNING</b>	<p><b>California Proposition 65 Warning</b></p> <p><b>Battery warning</b></p>
<p>Battery post, terminal and related accessories contain lead compounds, chemicals known to the State of California to cause cancer and other reproductive harm. <b>Wash hands after handling battery or battery cables.</b></p>	

## Electric system and handling the battery

Always handle the battery with care. Follow the safety instructions given below. The battery of the 12 v electric system of the loader is located under a cover plate under the floor of the loader. See page 69 for more information about battery and maintenance instructions.

### **WARNING**

Short-circuit of the battery can create fire or explosion. Disconnect the battery with the battery disconnect switch before working on the engine or equipment. Never lay metal objects on the battery.

### **WARNING**

Battery acid can cause severe skin burns. Handle damaged battery with extreme care and wear appropriate safety gloves and clothing. Battery is a sealed type battery, meaning that you should never attempt to open the battery.

### **WARNING**

Lead acid batteries produce flammable and explosive gases during charging. Make sure that ventilation is sufficient when charging the battery. Keep arcs, sparks, flames, and lighted tobacco away from battery.

Never charge a frozen battery. A frozen battery can explode during charging.

### **CAUTION**

Battery and its terminals contain lead, a harmful substance which should not be handled more than what is necessary. Wash hands with soap and water after handling the battery.

- Battery contains corrosive sulphuric acid which causes serious burns upon skin contact. Avoid contact with skin or clothes. If electrolyte gets on your skin or clothes, flush with a lot of water. In case of contact with eyes, flush with a lot of water for at least 15 minutes and see a doctor immediately.
- In order to avoid spark emissions, always disconnect the negative (-) cable first and connect it last.
- Before connecting the battery cables make sure that the polarity is correct: Faulty connection will seriously damage the electric system of the engine and may cause sparks, fire, or explosion of the battery.
- If fuse is blown repeatedly, find out the cause. Always use fuses with correct rating.
- Read the instructions for jump start, see page 78

## Working near powerlines

Digging may expose buried electric cables, and some attachments may make it possible to reach overhead powerlines with the loader, creating hazard of electric shock and electrocution.

Plan work ahead and take necessary safety precautions.

### Stay away from electric cables - Electrocution hazard

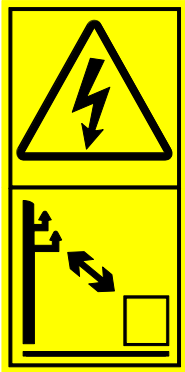

Electric shock hazard - Contact with or working too close to electric wires can result in lethal electric shock. Keep the loader and any attachment at a sufficient distance from all electric cables, see table below.

**Table 1 - Safety distance from powerlines**

Voltage level	Safety distance
0 - 1000 V	2 m
1 - 45 kV	3 m
110 kV	4 m
220 kV -	5 m
Unknown voltage	5 m

If electric cables are exposed during digging, or in case of inadvertent contact or proximity with live electric source:

- Do not leave the loader until the electricity has been disconnected by qualified technicians, usually local electric company.
- If absolutely necessary, jump out from the loader, keeping feet next to each other, until at a safe distance.
- Warn others not to approach the loader until safe to do so.

## Handling fuel (220/225)

Refuel with correct type of fuel specified in this manual, and follow refuelling instructions on page 52. Store fuel carefully in an approved container away from heat and sources of ignition.

Always have correct type of fuel tank cap fitted and avoid spilling of fuel.

### Risk of fire or explosion - Handle fuel with care



- Always stop the engine and allow it to cool before refuelling.
- Refuel only in a well ventilated area.
- Do not overfill the fuel tank. Leave at least 50 mm below the neck of the fuel tank to avoid spilling of fuel.
- Avoid spilling fuel when refuelling. Should this happen, wipe the fuel away immediately in order to avoid risk of fire.
- Keep fuel away from sources of ignition. Do not smoke during refuelling.



## LPG Fuel - Safety (225LPG)

Liquefied Petroleum Gas is extremely flammable and is heavier than air and tends to settle in low areas where a spark or flame could ignite gas.

Do not start or operate this engine in a poorly ventilated area where leaking gas could accumulate and endanger safety of persons in area.

Handle the LPG equipment with care and stop the use of the loader immediately if you think that it may be damaged. Contact authorised service to sort out the problem.

See storage instructions on page 55.

*Fuel can explode or burn, risk of severe burns and personal injury - No smoking or open flames near fuel*



- Always stop the engine and allow it to cool before changing a gas cylinder.
- Close the manual valve of the gas cylinder and let the engine run until gas hoses are empty before disconnecting any fitting.
- Make sure you use correct type of LPG gas and that hose fittings are correct for the bottle type.
- Always keep LPG cylinders in upright position. Store LPG gas bottles correctly. See page 55.
- Keep fuel away from heat and sources of ignition. Do not smoke when handling gas.
- Leaking gas is heavier than air.

## Safety of LPG systems

Keep the entire LPG system in good condition to keep the LPG system safe and to avoid leaks. Use only correct type of gas bottles, refer to page 30.

Improperly installed and maintained gas equipment can cause fuel supply system or other components to malfunction, causing gas leaks. It is recommended to have the LPG system inspected annually (hoses, fittings, pressure regulator). Propane fuel supply systems must be installed and serviced only by qualified service professionals. Observe all local regulations concerning the handling of LPG equipment.

## Handling of LPG bottles

Always keep gas bottle upright. This ensures that the overpressure relief of the bottle can function as intended.

Stop the engine and switch off the main current with the battery disconnect switch before changing the gas bottle.

Make sure the gas bottle has an overpressure relief valve fitted. Pressure inside the gas bottle depends on ambient temperature. In case of overpressure in the cylinder, the overpressure relief valve will vent out propane to keep pressure inside the tank at a safe level.

Close the manual shut off valve on the gas bottle carefully, do not overtighten the valve. Typically the valve needs to be opened about 2-3 rounds to be fully open.

Notice the inspection year that has been marked on the bottle. The gas bottle must be inspected by a licenced professional before the year marked on the bottle. If there are no markings on the bottle, or the inspection date has passed, the gas bottle must be taken out of service and returned to the retailer.



**Risk of gas leak, fire or explosion - Handle gas bottles with care.** Disconnect the gas cylinder from the loader and store it separately in an area designated for safe propane storage, see page 55. If the gas bottle is damaged, or if damage is otherwise suspected, remove it from service and take it to exchange point or qualified inspector.

### **Filling of gas bottle**

In some areas empty gas bottles are exchanged to full ones, and in other areas they are filled. Filling of a gas bottle requires special equipment and training. If filling a bottle, the condition of the bottle and the valve must be checked by a qualified specialist. Only professionals who have been trained to fill gas bottles and have a valid licence are allowed to fill a gas bottle. Never attempt to fill a gas bottle without special equipment needed to avoid risk of explosion.

### **Use with LPG only**

Do not use natural gas or any other gas that contains methane (common names for these include biogas EPG / CBG and CNG). In addition to the differences in composition between these and other gases, the working pressures and the gas systems themselves can be very different. This loader is intended to be used only with a gas bottle that contains propane.



**Risk of fire or explosion - Use only correct LPG gas and gas bottle.** If you use other gas types, there is a serious risk of fire and explosion, or engine damage at minimum.

### **In an event of a gas leak**

In case you suspect a leak in the gas system:

- Close the manual shut off valve of the gas bottle immediately if suspecting a leak.
- Stop the engine with ignition key and switch off the main current.
- Ventilate well before investigating the cause of the leak.
- To check components for gas leaks, see page 18.

If a leak in a propane fuel system occurs, the heavier than air gas will sink to lowest parts of the room and remain there, creating a risk of explosion and fire. Therefore it is very important to ventilate enclosed areas well to remove all remaining gas. Replace faulty components with new ones, never attempt to repair damaged components. Contact authorised Avant service if necessary.

# Description of the loader

## Identification of the loader

Write down the identification information of your loader in the following fields, it facilitates ordering of spare parts etc.

1. Loader model \_\_\_\_\_
2. Loader serial no. \_\_\_\_\_
3. Engine serial no. \_\_\_\_\_

Serial number of the loader is printed on the type plate, which also indicates the loader model. Location of engine serial number can be found in the Operators Manual of the engine.

Dealer: \_\_\_\_\_

Contact information \_\_\_\_\_  
\_\_\_\_\_

## ***Loader identification***

Loader identification plate is located near the left knee of the driver.



## ***Engine identification***

Engine identification plate is visible under the seat on the side of the engine. Further details are shown in the engine operator's manual.



## **Main parts of the loader**

Following picture shows the main parts of the loader:



### **1. Front frame**

On the front frame are mounted: driver's seat, operating controls, engine with accessories, battery, hydraulic components, fuel tank, oil tank, front wheels with hydraulic motors, and loader boom with attachment coupling plate.

### **2. Back frame**

On the back frame are mounted: rear wheels with hydraulic motors, counterweights, trailer coupling.

### **3. Articulation joint**

Articulation joint connects the front and back frame. The loader is steered hydraulically by the steering cylinder which is mounted between the front and back frames. Hydraulic hoses and electric wires are conducted through the articulation joint.

### **4. Loader boom**

Loader boom is mounted on the front frame and is controlled with control lever from the driver's seat. The attachment coupling plate is mounted at the end of the boom. The boom is fitted with a mechanical parallel linkage.

### **5. Attachment coupling plate**

Attachments are mounted on the attachment coupling plate. The locking pins on the plate are manually operated type.

### **6. Auxiliary hydraulics outlet**

The hydraulic hoses of hydraulically operated attachments are mounted on this outlet. The outlet is equipped with the multi connector quick coupling system and is double acting: it has two pressure lines and one tank line, see page 61. If the loader is equipped with the optional Attachment control switch pack, its electric socket is integrated in the multi connector.

### **7. ROPS safety frame**

ROPS frame (Roll-over protective structure) complies with the standard ISO 3471:1994 with Amendment 1:1997 and Technical Corrigendum 1:2000 for a maximum machine configuration mass of 1200 kg.

### **8. FOPS canopy**

FOPS canopy (Falling objects protective structure) mounts on the ROPS. It meets the ISO 3449:2005 (1365 J) criteria.

### **9. LPG Gas bottle (225LPG)**

Vertically installed gas bottle, from which gas is drawn in vapour form. See page 30.

## **Signs and decals**

Shown in the figure below and listed on the following page are the labels and markings, which must be visible on the equipment. Replace any warning label which has become unclear, or has detached completely. New labels are available via your retailer or contact information provided on the cover.

Before applying a new decal, clean the surface from dirt, dust, grease, or other material. Peel small portion of the decal backing paper and apply exposed adhesive to cleaned surface, aligning the decal properly. Peel rest of backing paper and press with hands to smooth out the decal.



The warning labels contain important safety information and they help to identify and remember the hazards related to the equipment.

Make sure that the following signs and decals are clean, undamaged and readable. If any of these decals is missing or is unreadable it should be replaced without delay. Ask for new decals from your local Avant dealer.

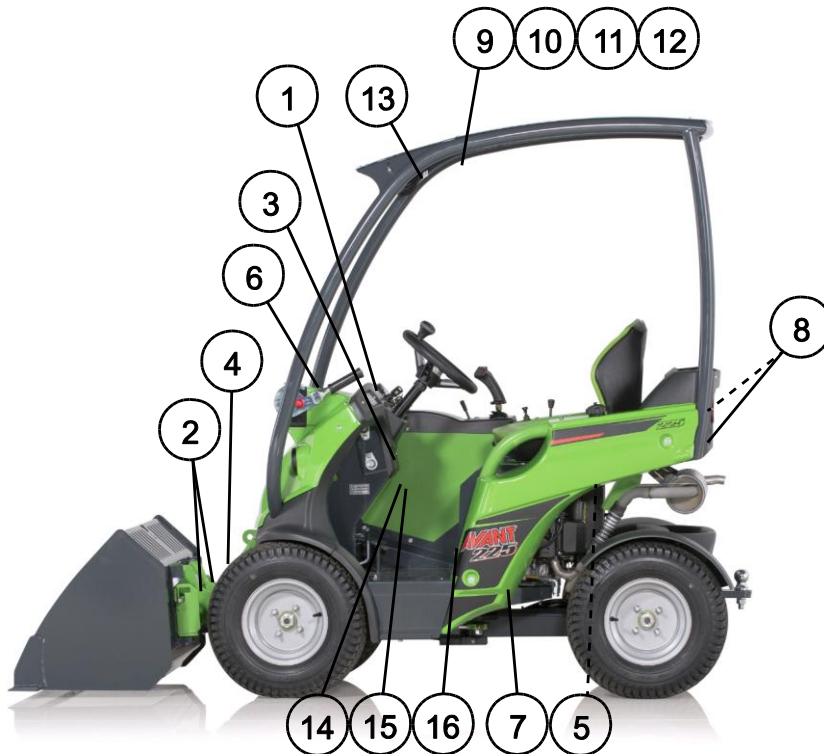





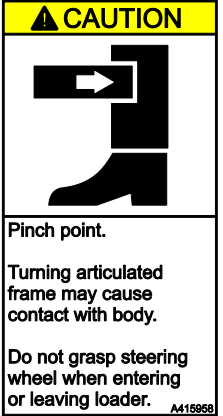



Table 2 - List of safety labels and markings on the machine (continued on following pages)

Label	Location	Product code
<p>1</p>	<p>Dashboard, around / behind steering wheel</p>	<p>A421186</p>
Symbol or Message		Safety message
<p>a</p>	<p>b</p>	<p>a Wrong use, misuse, or careless use can cause hazards that could be prevented with following the instructions properly. Read all instructions carefully before operating the loader.</p> <p>b Always wear seat belt.</p>
		<p>c <b>WARNING</b></p> <ul style="list-style-type: none"> <li>▪ Read operator's manual before using or servicing this machine or its attachments.</li> <li>▪ Follow all safety procedures, warning labels, and attachment operator's manual.</li> <li>▪ Always fasten seat belt. Never remove or modify safety structures.</li> </ul>
		<p>d</p> <ul style="list-style-type: none"> <li>▪ Wear hearing protection, safety boots, and other proper personal protection equipment called for by job conditions. Do not wear loose clothing while operating or servicing this machine or its equipment.</li> <li>▪ Follow safe stopping procedure.</li> <li>▪ Never carry passengers or lift other persons. Keep children and bystanders off and away from machine.</li> </ul>
<p>e</p>	<p>f</p>	<p>e Wear hearing protection. Depending on use, noise level at driver's seat and around the loader and its attachments may be high enough to cause hearing damage.</p> <p>f Wear safety boots with good grip and feet protection</p>
<p>g</p>		<p>g Wear protective gloves with good grip.</p>



Label	Location	Product code	Safety message
<p>2</p> 	<p>Boom, on both sides</p>	<p>A421338 (2 pcs)</p>	<p><b>DANGER</b></p> <p><b>STAY AWAY FROM LIFTED LIFT ARM OR ATTACHMENT</b></p> <p>Lowering of loader boom can crush, causing death or serious injury.</p> <p>Keep out from the danger zone of the machine.</p>
<p>3</p> 	<p>Panel below steering wheel</p>	<p>A421171</p>	<p><b>WARNING</b></p> <p><b>TIPPING OVER CAN CAUSE DEATH OR SERIOUS INJURY</b></p> <ul style="list-style-type: none"> <li>▪ Always carry bucket or attachment as low as possible.</li> <li>▪ Keep seat belt fastened and stay within the Roll over protective structure</li> <li>▪ Drive slowly and do not turn sharply when carrying loads, driving on uneven terrains or at high speed.</li> <li>▪ Always watch out for steep gradients, ditches, and manholes.</li> </ul>
<p>4</p> 	<p>Boom, near quick coupling plate</p>	<p>A421645</p>	<p><b>WARNING</b></p> <p><b>AVOID DEATH OR SERIOUS INJURY</b></p> <p>Driving without an attachment increases risk of tipping over.</p> <ul style="list-style-type: none"> <li>▪ Drive slowly and avoid sharp turns when operating the loader.</li> <li>▪ Follow all safety messages and instructions.</li> </ul>
<p>5</p> 	<p>On engine</p>	<p>A417270</p>	<p><b>WARNING</b></p> <ul style="list-style-type: none"> <li>▪ <b>Extremely hot surfaces - Risk of burns.</b></li> <li>▪ <b>Keep clear.</b></li> </ul> <p>Allow loader to cool completely before maintenance.</p>

Label	Location	Product code	Safety message
<p>6</p>		<p>Near attachment Faster coupling</p>	<p><b>WARNING</b></p> <p><b>High pressure fluid hazard</b></p> <p>To prevent serious injury</p> <ul style="list-style-type: none"> <li>■ Release hydraulic system pressure before disconnecting or repairing.</li> <li>■ Use wood or cardboard when searching for leaks, do not use hands.</li> <li>■ Keep all components in good condition.</li> <li>■ Consult physician immediately if skin penetration occurs.</li> </ul>
<p>7</p>		<p>Near access step</p>	<p><b>CAUTION</b></p> <p><b>Pinch point</b></p> <p>Turning articulated frame may cause contact with body.</p> <p>Do not grasp steering wheel when entering or leaving loader.</p>
<p>8</p>		<p>Rear ROPS posts (2 pcs)</p>	<p><b>WARNING</b></p> <p><b>Hot exhaust - Keep clear.</b></p> <p>Exhaust gases and all parts of exhaust system become extremely hot during use.</p> <p>Stay clear of any exhaust part until engine is allowed to cool, avoid also reversing or leaving loader near flammable materials.</p>

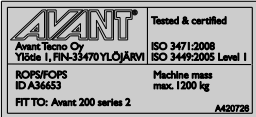
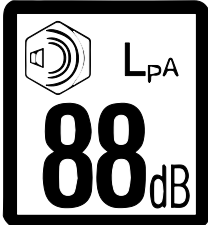
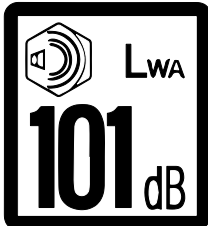

Label	Product code	Message
<p>9</p>	<p>A415954</p>	<p><b>WARNING</b></p> <p><b>Overturning of machine can lead to death or serious injury.</b></p> <p><b>Follow safety instructions.</b></p> <p>Safety instructions</p> <ul style="list-style-type: none"> <li>Always carry bucket or attachment as low as possible, and with the telescopic boom completely retracted.</li> <li>Drive slowly and do not turn sharply on uneven terrains. Watch out for ditches, manholes, and steep gradients.</li> <li>Never transport persons with the machine. Keep children and bystanders off and away from the machine.</li> </ul>
<p>10</p>	<p>A417274</p>	<p><b>WARNING</b></p> <p><b>Noise hazard</b></p> <p>Noise level at driver's seat will reach 88 dB(A), or higher, depending on use and type of attachment.</p> <p>Continuous exposure to noise above 80 dB(A) may cause hearing impairment</p> <p>Wear appropriate hearing protection.</p>
<p>11</p>	<p>A415957</p>	<p><b>SAFE SHUTDOWN PROCEDURE</b></p> <p>See page 88 for full contents of the label.</p>
<p>12</p>	<p>A415956</p>	<p><b>SAFE OPERATING INSTRUCTIONS</b></p> <p>See page 44 for full contents of the label.</p>

Table 3 - Information labels

Label	Location	Product code	Message
13		ROPS frame	ROPS/FOPS Approval
14		Right panel near driver's seat	Sound pressure level 88 dB(A) at driver's seat
15		Right panel near driver's seat	Sound power level 101 dB(A) 2000/14/EC
16		Front panel below driver's seat	Correct type of hydraulic and engine oil

# Technical specifications

## Dimensions

General dimensions							
Length	1910 mm 225LPG: 1940 mm						
Width	1025 mm (with standard tyres) 995 mm (see <b>page 29</b> )						
Height	1880 mm (with standard tyres)						
Mass (empty)	<table border="1"> <tr> <td>220</td> <td>700 kg</td> </tr> <tr> <td>225</td> <td>700 kg</td> </tr> <tr> <td>225 LPG</td> <td>760 kg</td> </tr> </table>	220	700 kg	225	700 kg	225 LPG	760 kg
220	700 kg						
225	700 kg						
225 LPG	760 kg						
Tyres	Standard: 20 x 8.00-10 TR / 20 x 8.00-10 GR						
Lifting height	1400 mm						
Max reach	810 mm						
Turning radius, inside/outside	910 mm / 2220 mm						
Ground clearance	150 mm						

## Drive speed and pulling force

	Tyre	Drive speed	Pulling force
<b>220</b>	20 x 8.00-10 TR	10 km/h	6200 N
	20 x 8.00-10 GR	10 km/h	6200 N
<b>225 LPG</b>	20 x 8.00-10 TR	10 km/h	6400 N
	20 x 8.00-10 GR	10 km/h	6400 N

## Height and Width

Tyre	Height	Width
20 x 8.00-10 TR	1880 mm	995 mm
20 x 8.00-10 GR	1880 mm	995 mm

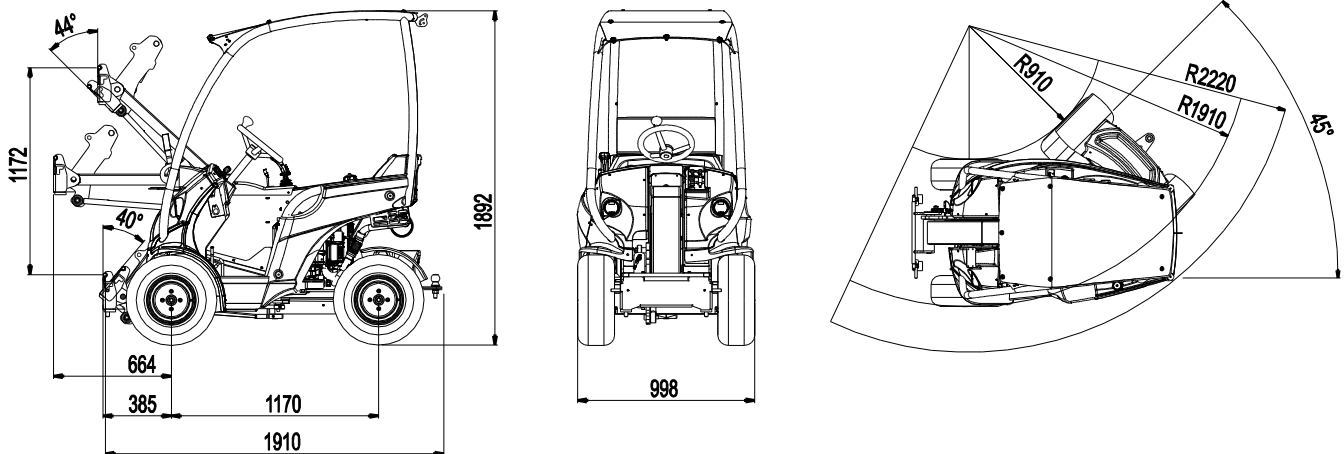

## General specifications

	220	225	225LPG
Category	Earth-moving machinery / Loader/ Compact loader EN ISO 6165		
Product code	A21675	A21687	A21698
Drive system	Hydrostatic 4WD		
Tipping load ISO 14397-1 (see also page 32)	320 kg	320 kg	350 kg
Rated operating capacity	175 kg	175 kg	200 kg
Auxiliary hydraulics *See also page 31	Max 20,0 MPa (200 bar)	Max 20,0 MPa (200 bar)	Max 20,0 MPa (200 bar)
	Max flow Front: 30 l/min Rear: 7 l/min	Max flow Front: 43 l/min Rear: 7 l/min	Max flow Front: 43 l/min Rear: 7 l/min
Hydraulic pumps	2	2	2
Auxiliary hydraulics	Standard: Faster multiconnector system on front		
Attachment coupling	Avant quick coupling attachment plate		
Hydraulic oil capacity	23 l		
Hydraulic oil type	ISO VG 46, mineral oil only		
Fuel tank capacity	14 l	14 l	Steel propane tank See page 30
Sound pressure level 2000/14/EC L <sub>p</sub> , ISO 6396	101 dB(A)	101 dB(A)	100 dB(A)
Sound power level 2000/14/EC L <sub>p</sub> , ISO 6395	88 dB(A)	88 dB(A)	88 dB(A)
Hand-arm vibration, total	< 2,5 m/s <sup>2</sup>	< 2,5 m/s <sup>2</sup>	< 2,5 m/s <sup>2</sup>
Whole-body vibration, max.	< 0,5 m/s <sup>2</sup>	< 0,5 m/s <sup>2</sup>	< 0,5 m/s <sup>2</sup>

## Engine

Model	220	225	225LPG
Engine	Kohler CV640	Kohler ECV730 EFI	Kohler PCV740 EFI
Engine max output	14,9 kW (20,5 hp), 3600 rpm	18,6 kW (25 hp) 3600 rpm	17,9 kW (24 hp) 3600 rpm
Operating principle:	4-stroke V2, OHV	4-stroke V2, OHV Electronic fuel injection	4-stroke V2, OHV Electronic fuel injection
Fuel (see page 30)	Gasoline	Gasoline	Propane (Propane/Butane)
Cooling	Air	Air	Air
Starting system	Electric	Electric	Electric
Displacement	674 cm <sup>3</sup>	747 cm <sup>3</sup>	747 cm <sup>3</sup>
Bore * stroke	77*67 mm	83*69 mm	83*69 mm
Engine oil	wet, oil pump, filter	wet, oil pump, filter	wet, oil pump, filter
Oil capacity (refill)	1.9 l	1.6-1.9 l	1.6-1.9 l
Engine oil:	SAE 10W-30 API CF-4/SG	SAE 10W-30 API CF-4/SG	SAE 10W-30 API CF-4/SG
Valve clearance	Hydraulic tappet	Hydraulic tappet	Hydraulic tappet

## Tyres

The loader can be equipped with different type of tyres for different operating conditions. Grass pattern (GR) tyres will damage the ground surface less than tractor (TR) tyres, but provide less traction.

Tyre	Tread pattern	Code	Fill pressure	Max pressure
20 x 8.00-10	TR	66231	2,3 bar	2,9 bar
20 x 8.00-10	GR	66252	2,3 bar	2,9 bar

For the best stability and controllability, always use the largest tyres possible.

Use only tyres and rims that meet the original specifications and dimensions to avoid potential issues with load capacity, tyre size, or bearing load on drive motors. Special tyres, such as studded wheels may also be available. Consult your dealer for further information.

Snow chains will not fit and are not available for the loader.



**Risk of tipping over - Make sure tyres are not damaged.** Loss of tyre pressure can cause loader to tip over. Make sure there are no visible damages on tyres. Keep tyre pressure within recommendations.

## Wheel spacers

The wheels are fitted with spacers that increase the width of the loader for better stability. In special cases where the width of the loader is restricted, the wheel spacers can be removed. Remove only if operating on flat areas. The spacers A44337 are 15 mm thick.

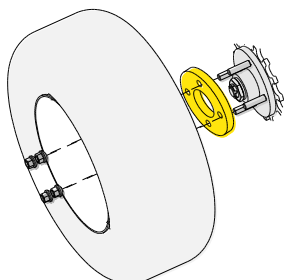

Wheel spacers improve the lateral stability of the loader. Do not remove the wheel spacers unless operating the loader on flat areas, where the total width of the loader must be reduced to as narrow as possible.



Use only spacers recommended by the manufacturer. Too thick spacers may damage the hydraulic motors. Contact your Avant dealer for more information.

## Wheel weights (optional extra)

Extra wheel weights can be fitted to improve stability of the loader. If fitting only two weights, they should be fitted to rear wheels.

The 14 kg weights are installed to wheel rim with two special bolts included in the kit as shown below.

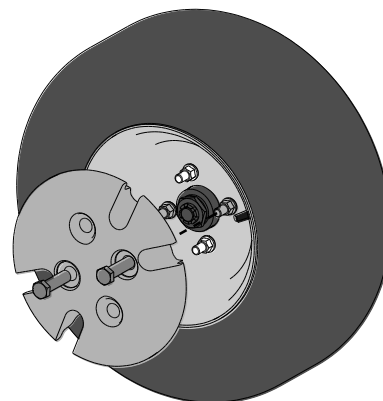

## Fuel requirements

### Gasoline requirements (220/225)

#### *Gasoline fuel must meet the following requirements:*

- Clean, fresh, unleaded gasoline from a clean container. Do not use gasoline older than 30 days.
- Minimum octane rating:
  - EU: Min 90 (RON)
  - North America: 87 (R+M)/2
- Bio fuel mixed with ethanol (max 10%) can be used.
- Gasoline blend with max 15% MTBE additive by volume (Methyl Tertiary Butyl Ether) is approved.
- Do not add oil to gasoline.

#### **NOTICE**

E15, E20 and E85 are not approved for use with the engine in the loader. Effects of old, stale or contaminated fuel are not covered by warranty.

### LPG gas requirements (225LPG)

Avant 225LPG is intended to operate with gas that flows as vapour from the bottle, not liquid. Regular, commonly available gas bottles that are also used for i.e. heating, grilling etc. and used in vertical position are correct type of gas bottles.

NOTE: The Avant 525LPG, another Avant loader model, uses different type of gas system with external vaporizer. This means that the gas bottles are not interchangeable between these two loader models.

#### **NOTICE**

The Avant 225LPG is intended to be used with gas bottles that are used in upright position and supply gas in vapour form, not liquid.

Make sure to use correct type of gas bottles, contact your local dealer for more information.

The exact type of gas bottle will depend on the area where the loader is used, but the following general instructions and requirements apply.

When replacing a gas bottle, take the following into account:

- The loader engine is certified to operate with commercial propane that complies with USA standard GPA STD 2140. This standard specifies that the maximum amount of butane is limited to a low level. If you operate the loader in cold climate, use LPG gas that is only propane.
- Bottle must supply LPG in vapor form, not liquid.
- Hose coupling must be threaded fitting, not any quick coupling type. Hose threading must match perfectly the hose threads. See page 31 for standard hose fittings and typical, available fitting options.
- Overpressure valve must be fitted and in functioning condition. Bottle itself and its valve must be inspected periodically by qualified technician. With bottles that are exchanged to full ones, this is usually managed by businesses offering exchange bottle service.
- Physical dimensions of the bottle must be within the following limits:
  - 300 mm in diameter
  - 700 mm height
- Stainless steel, steel, and aluminium bottle absorb heat the best. Do not use plastic / composite bottle, they will not absorb heat from surrounding air effectively
- Larger bottles absorb more heat than smaller ones.

### Gas hose fittings

The hose connecting the gas bottle has fitting that might need to be replaced, if planning to operate with another type of gas bottle. If different type of fitting is necessary, contact your local Avant dealer. Use only fittings that are of correct size and thread type. Make sure the fittings seal correctly. Do a gas leak test after you have installed all fittings, refer to page 77.

Connects	Thread
Gas hose to pressure regulator	UNF 5/8"-18 SAE 45°
Gas hose to gas bottle	R3/8"
Standard adapter for gas bottle	Adapter RU 3/8" LH -> DIN 477 W21,8 x 1/14" LH O-ring

### Engine oil requirements

Use only high quality engine oil with the viscosity rating recommended by the engine manufacturer with API service class SJ or higher. See also Kohler Operator's Manual.

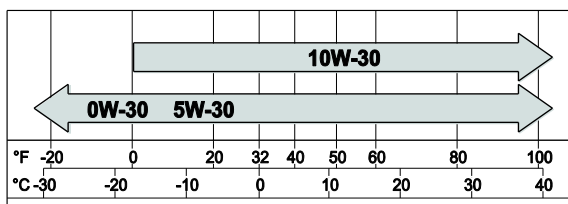

In cold conditions use high quality multi grade oil.

### Auxiliary hydraulics oil flow

The graph below shows auxiliary hydraulics output flow at different engine rpm levels.

Some attachment may work optimally at certain flow level, use the graph to estimate correct engine rpm setting.

**NOTICE**

Maximum auxiliary hydraulics oil flow can not be used with all attachments. Check correct engine rpm for the attachment with the help of this graph and the Operator's Manual of the attachment. Attachment may get damaged, run too fast, or it may be difficult to control precisely when oil flow is too high.

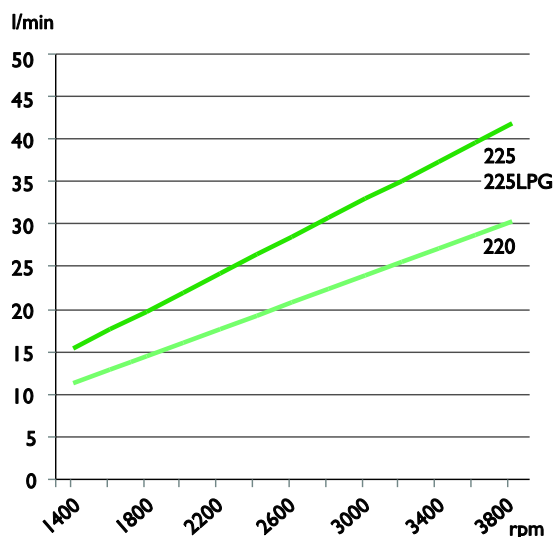

## Tipping load

Tipping load is the load at which the rear tyres lose contact with the ground (tipping forward). Tipping load is influenced by several factors:

- The total load on the loader boom (attachment weight and load combined)
- The distance of the load from the front tyres
- Straight or articulated position of the loader frame
- Levelness of the ground
- Installed counterweights
- Driver presence
- Movements of the loader and the load

### Load diagram

With the diagram the load handling capability of the loader can be evaluated, according to the distance between the centre of gravity of the load and the front axle of the loader. The diagram represents the forward stability only, *it does not refer to maximum available lift force*.

The load diagram below shows the tipping loads on a level surface:

- a) Tipping load with the loader frame in straight position.
  - b) Tipping load with the loader frame in maximum articulation.
- ROC (Rate operating capacity), defined as 60 % of tipping load for pallet forks.

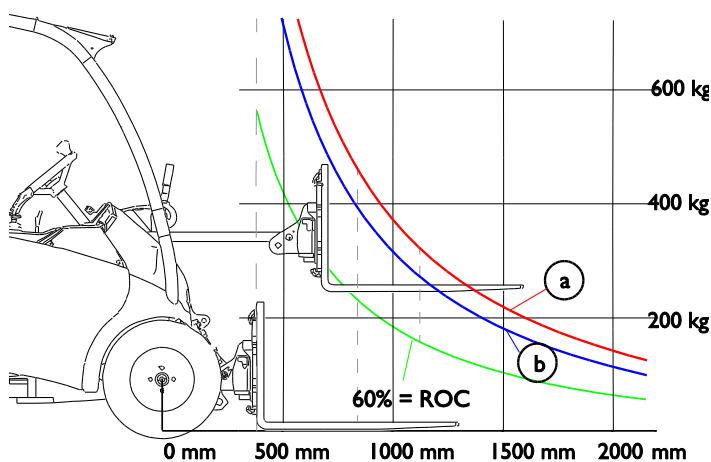

Overload will cause the loader to tip forward.

The operator must pay attention to safe operating conditions whenever handling loads or heavy attachments.

The lifting capacity and the stability of the loader are at the best, when:

- the loader frame is kept straight
- the centre of gravity of the load is as close to the loader as possible
- counterweights are fitted to the loader
- swinging of the load is prevented and all controls are used in a calm and careful manner

Example: If the centre of gravity of the load is 840 mm in front of the front axle (400 mm from the pallet forks at ground level), the tipping load is about 390 kg with a driver weighing 75 kg and with the articulated frame turned to max articulation.



If the driver leaves the machine, tipping and max. loads are reduced respectively.

The indicated load is the maximum load that can be loaded on pallet forks and the machine will not tip over, i.e. the weight of the pallet fork attachment (95 kg) is taken into account.



Avoid overloading the loader - know the load and lifting capacity of the loader. The diagram is valid only on firm and level ground, with the conditions listed above.



## Rated operating capacity

To determine how much the loader can handle safely, a table of the tipping load and a calculated Rated Operating Capacity (ROC) is shown in the adjacent label. The label is also visible from the driver's seat.

Rated operating capacity depends on type of use of the loader:

- In bucket and general application the rated operating capacity is 50% of tipping load
- In pallet fork application the rated operating capacity is 60% of tipping load

The information shown in the table is the worst case minimum load, with the conditions listed below. Actual lifting capacity could be significantly higher, or it may be lower, depending on terrain conditions, available lifting force, and load distribution. Adding or removing counterweights will affect the indicated ROC.

The ROC table is valid, when:

- The ground is firm and level
- Loader is stationary or driven max 2 km/h, with smooth and slow control movements
- Driver 75 kg is seated on the driver's seat
- Load is distributed evenly on pallet forks, with the load centre of gravity at 400 mm from the vertical part of pallet fork arms. The weight of the fork attachment is taken into account in the indicated load values.

## *Rated operating capacity*



### *Different loader configurations, rows in the label:*

1. Loader frame in straight position, standard counterweight fitted
2. Loader frame in fully articulated position, standard counterweight fitted

### *Different positions of the loader boom, columns in the label:*

1. Maximum tipping load, stability when lifting load just off the ground
2. Boom lifted to horizontal position (least stable position)
3. Rated operating capacity in pallet fork application

# Controls of the Loader

Following picture shows the location of operating controls. The location and function of controls may be slightly different in different models, see following pages.

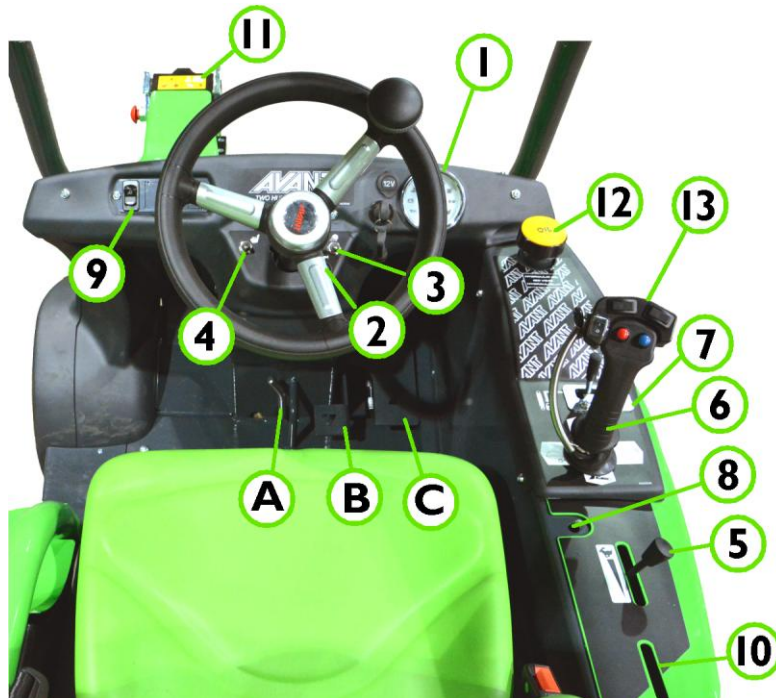

Reference	Page
1. Multi-Function Display	35
Ignition switch	46
12 V outlet (max 15 A)	39
2. Signal horn	
3. Work light switch	
4. Seat heater switch	40
5. Hand throttle lever	37
6. Control lever of boom and bucket	36
7. Auxiliary hydraulics control lever	36
8. Choke knob (220 only)	46
9. Switches, see table below	
10. Rear auxiliary hydraulics control lever (optional extra)	39
11. Multi connector for attachment coupling	60
12. Hydraulic oil filling and dipstick	70
13. Attachment control switch pack	37

## Switches on the panel

	Emergency blinker (option)		Warning beacon (option)		Windscreen wiper and washer (CAB L option)		Extra work lights on the ROPS frame, 2 front, 1 rear (option)
--	----------------------------	--	-------------------------	--	--	--	---

## Controls in the footwell

- a Parking brake lever
- b Drive pedal, left: drive backward
- c Drive pedal, right: drive forward

See correct operation of the drive pedals on page 48.

## Parking brake lever

The loader is equipped with mechanical parking brake that locks the front wheels. When locking or unlocking the brake, turn the steering wheel sharply or press gently on the drive pedals, so that the locking pins lock or unlock.

- Lock: turn left and down into locking position.
- Release: turn right and up to release parking brake.

## Dashboard

The multi-function display includes indicator related to features on the loader and the engine, a fuel level metre, and an hour metre. The display is backlit whenever standard work lights or the road traffic lights are switched on. The hour metre runs whenever the engine is running.



### Indicator lights

	Symbol	Colour	Remarks
1		Red	<b>Low engine oil pressure</b> Stop engine immediately. Low oil pressure can cause severe engine damage. Check first if low pressure is caused by low engine oil level.
2		Red	<b>Charge indicator</b> Battery discharging - limited electric power supply of the loader may not allow to use all electric features simultaneously. If indicator is lit, switch off electric devices, or increase engine RPM for higher charging current.
3		Red	<b>Temperature indicator</b> <i>Not active on 200 series loaders.</i> If lit during operation, light refers to too high hydraulic oil temperature, allow to cool.
4	<b>MIL</b>	Red	<b>MIL (225 only)</b> Engine Malfunction Indicator Light, see page 78.
5		Yellow	<b>Fuel level low</b> <i>(not in use in 225LPG)</i> See page 52.
6		Blue	<b>High beam headlights on</b> Road traffic light kit only
7		Red	<b>Hydraulic oil cooler fan fuse</b> Hydraulic oil cooler malfunction. See page 79

	Symbol	Colour	Remarks
8		Green	<b>Turn signal indicator</b> Road traffic light kit only
9		Green	<b>Seat heater on</b> Suspension seat only

#### NOTICE

The charge indicator lamp may remain lit after starting the engine. After running the engine with higher RPM, the light will turn off.

#### NOTICE

Engine oil pressure and charge indicator lights should light up for a brief moment when ignition key is turned to ON position. If not, repair before using the loader.

## Control of loader boom, auxiliary hydraulics and other functions

Most of the functions of the loader are controlled with the controls at the right side of the operator: Boom and bucket movements, auxiliary hydraulics (attachments), engine revs etc. , depending on loader model. Following paragraphs show the different functions.

### 1. Control lever of boom and bucket

The loader boom and bucket are controlled with the multi-function lever sideways (tilt) and back & forward (boom up & down).



- Pull backward to lift the boom
- Push forward to lower the boom
- Push left to raise the tip of the bucket (filling)
- Push right to lower the tip of the bucket (emptying)

### 2. Control lever of auxiliary hydraulics (hydraulically operated attachments)

Hydraulically operated attachments are connected to the loader using the multi connector system, for more information see page 61.

- Operation directions depend on the attachment used.
  - When using an attachment for the first time, carefully move the lever to test and check the operating direction of the attachment.
- For continuous operation of rotating attachments, turn to direction 1 and turn to locking position.
- If operating the buttons of the electric joystick, this lever will not move on 200 series loaders. Either the lever or the buttons can be used to control the attachment as needed.

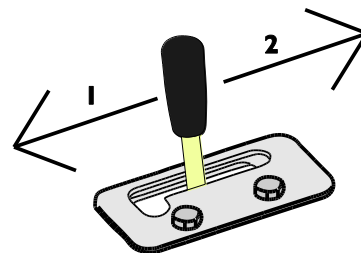

#### NOTICE

When you operate attachments that require continuous flow, such as attachments with hydraulic motors, it is important to have the control lever in fully engaged position. If the control valve is not fully open, restricting the flow of hydraulic oil, hydraulic system may overheat quickly.

If necessary, adjust the locking plate so that the lever is locked to fully open position.

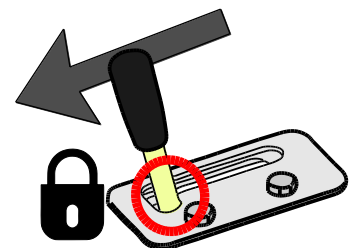

### **3. Joystick - 6 function (optional extra)**

If the loader is equipped with the optional 6 function joystick, the auxiliary hydraulics can be controlled with electric buttons on the joystick:



- Push and hold either button to operate hydraulic feature of the attachment. While holding a button, the manual control lever also moves to corresponding direction.
- The operation of the buttons depends on the attachment, see Operator's Manual of the attachment.
- Release buttons to stop.
- Make sure the manual control lever is not locked when operating electric joystick.



**Avoid abrupt movements of an attachment - Use electric buttons with caution.** When you use certain attachments with the electric joystick buttons, the attachments can move abruptly. This can cause falling of material from the attachment, loss of stability, or damage to attachment.

### **4. Attachment control switch pack (optional extra)**



If your loader is equipped with the optional attachment control switch pack, the electric functions of an attachment can be controlled with the extra buttons fitted on the joystick.

When the loader is equipped with the Attachment control switch pack, the Multi connector ( see page 61) includes also an electric socket, so that the hydraulic hoses and the electric cable of an attachment with electric function(s) can be coupled simultaneously with the multi connector system.

### **Hand throttle lever**

The engine running speed is controlled with the hand throttle lever.

- Push forward to increase engine rpm
- Pull backward to reduce engine rpm

The engine rpm affects the driving speed and can be used to control driving speed in combination with the drive pedals.

Engine speed also has an effect on the speed of a hydraulically driven attachment; the more throttle the faster the attachment operates. Make sure not to exceed max. allowed oil flow of the attachment, see **Auxiliary hydraulics oil flow** on page 31.

---

Check the operator's manual of the attachment to see how to control each attachment.

---

## Engine compartment

To access the engine, unlock the seat base by pulling the lever under the seat forward and tilt the seat forward:

1.



2.



### ⚠ WARNING

Allow engine to cool before accessing the engine. Engine and exhaust parts may be extremely hot after use.



The adjacent warning label is located on the engine. Hot areas include the engine in general, and especially its exhaust pipe(s) and surrounding areas.

### ⚠ CAUTION

Be careful when handling the seat base and keep hands and fingers clear when lifting or lowering - uncontrolled movements may crush or cut.

### ⚠ WARNING

Shut off engine and allow it to cool before accessing engine compartment. Moving or rotating parts may injure.

## Battery disconnect switch

The loader is equipped with a battery disconnect switch (main switch). The switch is located under the driver's seat in the engine compartment, on the left hand side.

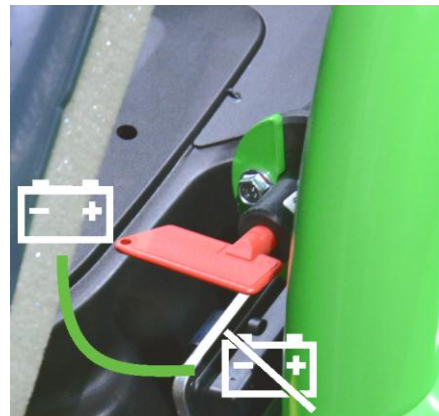

Battery disconnect switch cuts the current between battery and the rest of the electric system. Always switch off main current when the loader is not used for a longer period of time in order that the battery doesn't get empty, or when servicing the machine.

## Trailer coupling

The loader is equipped with a 50 mm ball hitch type trailer coupling for towing of light trailers.



- Max. allowed vertical load 2000 N
- Maximum towing load is 3000 N.



Overload on the trailer coupling may cause loss of control. Tow only light garden trailers. Make sure that the weight on the trailer is distributed correctly so that the trailer cannot cause an upward lifting force on the trailer coupling.

### **Rear auxiliary hydraulics outlet (option)**

In addition to the standard auxiliary hydraulics outlet, the loader can be equipped with a double acting extra outlet at the rear of the machine. The couplers are conventional type quick couplers, fitted near the trailer coupling.

- The extra outlet is controlled with its own, 2 direction control lever on the right from the driver's seat.
- Release the lever to neutral position to stop the attachment.
- Test the operation of the attachment after each time it is coupled to the loader. The quick couplings can be coupled in a way that reverses the function of the control lever.
- Both the front and rear hydraulics can be operated simultaneously.
- Keep the couplings clean and use their protective covers.

To connect or disconnect rear hydraulic coupling, see page .

### **Engine heater (option)**

The loader can be equipped, as an option, with an engine heater for easier starting in cold outside temperatures. Engine heater socket (220V-240V) is on the right side in the rear of the machine.

### **Electric 12 V outlet**

When operating attachments with electric features, the electric harness of the attachment is connected to the 12 volt outlet on the dashboard. The standard type outlet is powered when ignition is switched on. Maximum current: 10 A.

### **Spark arrester (option)**

A spark arrester is a device that prevents emissions of flammable debris from the engine exhaust. If operating the loader in areas with risk of forest fire, a spark arrester must be fitted. A certified type of spark arrester may be required by local laws.

When fitting the spark arrester, make sure it is secured around the exhaust pipe and will not become loose due to vibration or heat stresses. Clean the spark arrester with metallic brush if necessary.

### **Reverse buzzer (option)**

A reverse buzzer gives an audible signal whenever reversing with the loader. This alarms others of an approaching machine and thus improves safety.

## Seat - Seat belt and seat adjustments

### **⚠ WARNING**

The seating capacity of the loader is one person only. Never carry passengers on part of the loader or with any attachment.

Always use seat belt while driving. Clean the seat belt regularly with a sponge, warm water, and soap. Use compressed air to clean the buckle.

Replace the seat belt if any damage is seen, or if the seat belt is exposed to high load or chemicals.

### Seat adjustments

Make sure that the seat is properly adjusted for easy reach to the operating controls and to keep vibrations transmitted by the seat at minimum. Long term exposure to vibrations may cause health effects. Also, as far as possible, keep the operating terrain in good condition to minimise vibrations.

### Standard seat

The distance of the seat from the steering wheel can be adjusted with the lever which is located under the front edge of the seat.



### Suspension seat (option)

The suspension seat has the following adjustments:

1. Seat position
  - The distance of the seat from the steering wheel can be adjusted with the lever which is located under the front edge of the seat
2. Arm rest angle adjustment
  - The angle of the arm rest can be adjusted by turning the roller under the arm rest
  - Adjust the arm rest to position which allows to use controls of the loader comfortably while keeping arm on the arm rest.
3. Suspension adjustment
  - By turning the knob counterclockwise suspension gets harder, by turning it clockwise the suspension gets softer
4. Angle of the back rest
  - The angle of the back rest can be adjusted by pulling the lever



### Seat heater

The suspension seat is equipped with an electric seat heater. Seat heater switch is located by the steering column and indicator light is on the multi-function display.



## Lights

### Work lights

The loader is equipped with standard work lights at the front of the loader, which are controlled with a switch near the ignition switch.

If the loader is equipped with the optional road traffic light kit, the standard work lights are replaced with road headlights.

### Extra work light kit (option)

The loader can be equipped with extra work lights, making it easier to work in low light. The lights are operated with the switch on the control panel ( see page 34).

### Headlight, beacon, blinker & reflector kit (option)

This optional equipment enables road traffic registration in certain countries. Requirements for road traffic use vary in different countries, please consult your local AVANT dealer.

### Warning beacon (option)

The beacon can be removed quickly by loosening its retaining screw and then by pulling the beacon out. Place the protective seal on the beacon stand to prevent water entering and damaging the connectors. Handle beacon with care. The beacon is sealed and its inner components cannot be replaced or repaired by user.

**NOTICE**

Beacon includes high-voltage components. Do not use or repair damaged beacon, replace with new one.

### Light control switch (road traffic light kit)

Loaders fitted with road traffic light kit have a multi-function control switch fitted to the steering column.



The switch has the following controls:

- Headlights
- High beam lights
- Signal horn (duplicate switch, both the switch on near the ignition key and switch on multi-function control are connected)
- Indicator turn lights

## CAB L (optional extra)

The Avant 220/225/225LPG can be equipped, as an option, with cab L. Shown in this chapter are the controls and features that differ from the standard ROPS model.



In case the normal opening on the left side of the loader is blocked, the windscreen can be used as an emergency exit.

If necessary, the windscreen can be broken with the emergency hammer located in the cab.

## Windscreen washer and wiper

On machines with cab L, the windscreen washer is operated with a switch on the left to the steering wheel. The switch has the following functions:



2. Spray washer fluid
1. Continuous operation
0. Off

The windscreen washer fluid tank is located near the left knee of the driver while seated on driver's seat.

## Cab Safety

Make sure visibility from the cab is adequate. Keep all window panels clean and clear of snow, ice, etc.

Familiarise yourself with the special drive features and space needs of this articulated loader, equipped with cab, on a flat, even and open place.

Remember that, when turning, the cab extends beyond the turning radius of the wheels. This should be taken into consideration especially when driving in confined spaces, in order that the rear of the cab will not get damaged.

# Operating instructions



**Always remember – safety first.** Test all the functions of the loader at an open and safe place. Make sure that there are no persons in the operating area of the machine and the danger zone of the attachment.



**Careless operation can injure you or bystanders - Keep the loader under control at all times.** Operating a powerful loader and its attachments requires the full attention of the operator. Do not perform distractive actions while operating, such as using mobile devices.



Pay attention to other machines and persons that are moving in the area. Make sure that there are no persons in the danger zone of the loader and the attachment. The danger zone of the loader covers the reach area of the loader boom, the turning area on the side and in the front and rear of the loader. Always put down the load when leaving the machine – the loader is not designed to stay with the loader boom and load lifted. Learn how to operate the loader in a safe place.



## Safe operating instructions label

The label shown below, placed on the inner roof of the loader, gives an overview of important information that is necessary to operate the loader safely. The information shown in the label is not sufficient by itself, always read the full operator's manual.

### SAFE OPERATING INSTRUCTIONS

**ALWAYS MAKE SURE THAT OPERATOR'S MANUAL IS AVAILABLE.  
MANUAL FOR ATTACHMENT MUST ALSO BE FOLLOWED AND AVAILABLE.**

- Always follow operator's manual and all safety labels and given instructions.
- Owner is responsible to be sure that all users are instructed on safe use and maintenance.
- Check engagement of locking pins before moving or lifting attachment. Always follow manual of the attachment for safe change and operation of the attachment.
- Keep all safety systems, guards and shields in place. ROPS and FOPS must be fitted.
- Keep hands, feet, and arms inside operator's enclosure at all times.
- Operating conditions could produce jerky movement. Operate machine controls only while seated on driver's seat. Use controls smoothly and fasten seat belt.
- Keep away from power driven components and hot surfaces. Hydraulic lines and components can be hot.
- Relieve hydraulic pressure before connecting or disconnecting hydraulic couplings.
- Escaping fluid under pressure can be invisible and can penetrate skin. Do not use hands to search for leaks.
- Do not operate machine in enclosed areas without proper ventilation.
- Keep children and bystanders off and away from machine. Never carry passengers.
- Always use seat belt. Wear hearing protection and other proper personal safety gear called for by job conditions. Do not wear loose clothing during use or service.
- For more information, service, or spare parts, contact your dealer or manufacturer.

A415956

## Starting the engine

Before starting the engine do the daily checks, (see "*Daily inspections*" on page 66). Adjust the seat and mirrors (if fitted) so that you have a good working position and unrestricted field of vision from the driver's seat. Check that all controls function correctly. See to it that the operating area is safe. Read and follow operating and safety instructions.

### **⚠ WARNING**

If auxiliary hydraulics is switched on during starting and there is a hydraulically operated attachment on the machine, the attachment can move suddenly and cause a dangerous situation.

- Make sure that the auxiliary hydraulics control lever is in neutral position during starting.
- Do not actuate the auxiliary hydraulics control buttons on the joystick (if fitted when) starting.

### **⚠ WARNING**

**Prevent unintended movements of the loader.** Keep hands and feet away from other controls of the loader while starting.

*Do not start the loader in enclosed space - Exhaust emissions can kill within minutes*

### **⚠ DANGER**

Exhaust emissions are toxic in concentrated amounts. Do not operate the loader in enclosed spaces or insufficiently ventilated spaces, i.e. open garage door first.

## Ignition key



## Open/close LPG bottle

Exact instructions of how to open or close the manual shut off valve of the LPG bottle depend on the manufacturer of the bottle.

- Open the LPG bottle just before starting of the loader.
  - Open valve fully, usually by turning 2-3 rounds counter-clockwise.
- Keep the shut off valve closed whenever not actively using the loader.
  - Do not overtighten.

### **NOTICE**

Close the gas valve carefully, do not overtighten the valve. Do not open the valve more than necessary, typically max. 2-3 rounds, depending on gas bottle type. Gas bottle valve and the gas hose normally tighten when turning clockwise. See markings on the bottle valve.

## To start the engine:

1. Perform daily checks (see **Maintenance & Service** on page 63)
2. Turn the battery disconnect switch to ON
  - Open gas bottle valve (225LPG only)
3. Move the hand throttle lever to idle position
  - Cold start, 220 only: Pull choke knob halfway or fully up
4. Make sure that auxiliary hydraulics is switched off (lever in neutral position), see page 36. *Do not press on the drive pedals.*
5. Turn the ignition key to the right, to ON position. Signal lamps on the multi-function display will light up briefly for self-check. Oil pressure and charge indicator lights will remain lit.
6. Turn the ignition key further to the right, to start position and hold until engine starts. Return key to ON position in controlled manner.
  - 220: Push choke knob slightly down once the engine has started. Depending on temperature, the knob may be pushed fully down immediately after start or after warming up for a moment first. Keep choke knob in full down position in normal use.

### NOTICE

Do not actuate the starter for more than 10 seconds at a time. If the engine does not start, wait for one minute before repeating attempt. If the engine does not start after a few attempts, or runs poorly, **See *troubleshoot*** on page 80 and the engine owner's manual.

### **After starting:**

### NOTICE

Allow the engine to warm up and engine oil to circulate in the engine for a moment before loading the engine or increasing engine revs.

### NOTICE

Make sure that all the warning lights on the control panel are off when the engine is running. If the engine does not start after a few attempts, or runs poorly, **See *troubleshoot*** on page 80.

## Stopping the engine (Safe stopping procedure)

The following label is placed on the inner roof of the loader and is visible from the driver's seat. The label describes the needed actions in order to shut down the loader to a safe state.

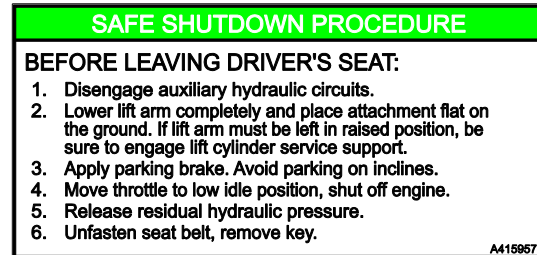

### **Text in label, Safe shutdown procedure**

#### **Before leaving driver's seat:**

1. Disengage auxiliary hydraulic circuits.
2. Lower lift arm completely and place attachment flat on the ground. If lift arm must be left in raised position, be sure to engage lift cylinder service support.
3. Apply parking brake. Avoid parking on inclines.
4. Move throttle to low idle position, shut off engine.
5. Release residual hydraulic pressure.
6. Unfasten seat belt, remove key.

**NOTICE**

Stop the engine as soon as possible, if any of the following symptoms is observed. Find out the cause before restarting.

- The oil pressure warning light, or malfunction indication light turns on during operation.
- Engine rpm increases and/or decreases suddenly by itself, without touching the throttle lever.
- A sudden and unusual noise is heard.
- Sudden increase in engine vibration.
- The colour of the exhaust fumes suddenly darkens or turns white.

**Run the LPG system empty**

Before replacing an empty LPG bottle, storage of the loader, or any maintenance work on the engine, empty the LPG fuel system.

- Shut off the manual shut off valve while engine is running
- Allow to run on idle until engine shuts down

## Drive control

### Principle of operation

AVANT 220/225/225LPG loaders are equipped with a hydrostatic drive system. This is based on a variable displacement hydraulic pump in the drive circuit that is proportionally controlled with the two drive pedals. Driving of the machine is controlled with the drive pedals and hand throttle.

- Suitable engine speed is selected with the hand throttle lever on the control panel, and desired driving direction and speed are controlled with the drive pedals.
- To get maximum pushing power push the pedals lightly – for higher travel speed push the pedal harder.

The basic rule for the hand throttle is: use lower revs for lighter work and higher revs for hard work or for high travel speed.



### **WARNING**

Familiarise yourself with the driving of the machine on low speed and on a flat, even and open place where unintended movements don't cause problems or danger. When you have learned how to drive on low speed, increase speed gradually and learn how to drive with higher drive speeds. Make sure that there are no persons in the operating area of the machine.

### Drive pedals

- Driving forward: press gently on the right drive pedal until the machine starts to move slowly.
- To drive backward: press gently on the left drive pedal.
- When you wish to stop gently release the pedal by lifting of your foot, and the machine will slow and stop.

### When you want to have a high pulling force:

1. Use high engine revs
2. Press the drive pedal only lightly to select a relatively slow drive speed. This way the full output of the hydraulic system and the engine can be taken out.

If the engine is overloaded while pushing, the pedal shouldn't be pressed further. Instead, use higher engine revs and push a pedal only a little.

### Drive release and anti slip

#### *Drive release valve*

The hydraulic drive circuit has a built in drive release system, which allows the wheels on the left and right side of the machine to roll at different speeds to leave less tyre marks on soft surfaces. The system automatically limits the flow of hydraulic oil between the hydraulic motors on each side, functioning in similar way as a limited parallel differential lock, increasing pushing force of the loader. The system is always engaged.

#### *Anti-slip valve (optional extra)*

If the loader is equipped with optional anti-slip valve, the valve positively diverts oil flow between the right and left side hydraulic motors and improves traction on slippery and uneven surfaces. Some oil will pass between the left and right side of the loader, and also through hydraulic motors themselves. This means that even though all wheels do not slip and spin equally, all provide maximum pushing force.

### Allow the loader to warm up properly

Hydraulic oil temperature has an effect on the hydrostatic transmission of the loader. When ambient temperature is below 5° C, let the engine run on idle and allow the engine and the hydraulic system to warm up properly before starting to drive. Drive carefully until the loader reaches its normal operating temperature.



**▲ WARNING**

When hydraulic oil gets warmer, driving characteristics of the drive system change. When the oil is hot and hydraulic oil cooler has switched on, stopping distance of the machine can be longer than when the machine is cold. If the machine is used constantly in high ambient temperatures, hydraulic oil type and viscosity must be suitable for these conditions. Contact Avant service.

**▲ WARNING**

Should there be a disturbance or malfunction in the hydrostatic transmission and consequently the braking force is not sufficient, engage the parking brake. The front wheels may lock immediately, use only in emergency.

**LPG in cold environment**

The 225LPG model is intended to operate with gas bottles that supply the gas in gaseous (vapour) form, not liquid. This means that the gas bottle acts also as the vaporizer. This will cause the bottle to cool substantially during use. Condensed water and frost may appear on the surface of the gas bottle in normal use. This is normal behaviour and not a sign of any trouble or a leak.

The gas bottle is less capable to vaporize gas in cool environment, and this sets a limit to minimum operating temperature where the loader can be used. Operating in cold conditions will cause decrease in engine performance, cause engine to run poorly, and can stop the engine. Condensed water and frost can appear on the surface of the gas bottle during heavy use, especially in cold ambient temperatures. See page 30 for information about the best type of gas bottle.

**NOTICE**

Condensed water and frost can appear on the surface of bottle in normal use. The gas bottle will absorb heat from ambient air to vaporize gas. Avoid using composite bottles for the best gas vaporization capability.

*Risk of explosion - Never heat a gas bottle externally*

**▲ DANGER**

The gas bottle can explode if heated. Allow the gas bottle to absorb heat naturally. Never remove frost from bottle by heating it intentionally.

## Steering of the machine

The machine is steered with the steering wheel. The steering wheel is hydraulically powered. A practical way of controlling the loader is to steer with your left hand on the knob of the steering wheel. This way your right hand is free to operate other functions.

In case the engine power is lost, turning the loader is possible through the integrated back-up steering system.

**▲ WARNING** When driving, always keep the loader boom as low as possible. Risk of tipping over increases considerably when there is a heavy load on the loader (a heavy attachment or a big load in the bucket) and the boom is up when driving.

**▲ WARNING** Never use a high drive speed when turning. In particular: when the loader boom is up the stability of the machine is much weaker when turning.

**▲ WARNING** Always remember that when turning the driver's seat extends beyond the turning radius of the wheels. Stay and keep hands and feet inside the safety frame (risk of collision and crushing).

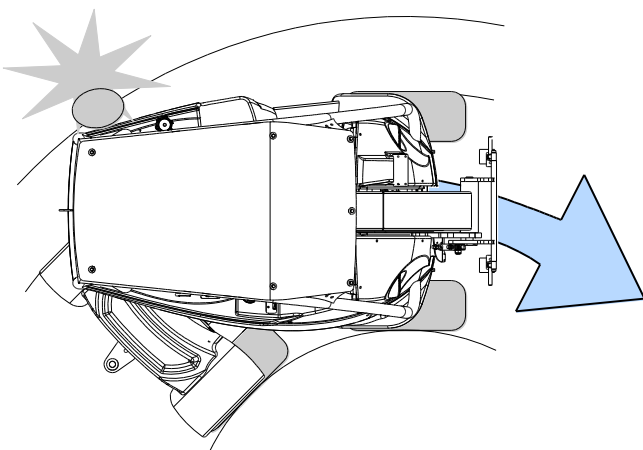

## In case the machine tips over

Avoid tipping over of the loader with careful operation and the instructions given throughout this manual. However, it is important to know what to do in case the machine tips over.

**▲ WARNING** Stay within the space protected by the ROPS safety frame. Always keep seat belt on to stay on driver's seat and to avoid getting crushed between ground and a loader that tips over.

**NOTICE** **In case the loader tips over**  
Shut down the loader engine immediately and disconnect battery by turning the main switch to OFF position. A running engine of an overturned loader will get damaged quickly and will spill hydraulic oil. As soon as possible, lift the loader back on its wheels to prevent spilling of fuel, and engine and hydraulic oils. The loader can in many cases be lifted back on its wheels by having a few persons to lift from the ROPS frame.

**NOTICE** To prevent severe engine damage, do not attempt to restart an overturned loader before oil is drained from the cylinders and thorough inspection of possible damages. Contact service.

## Material handling

Make sure to use correct type of attachment for each handled material. Use correct size and type of bucket for general loose material handling, and pallet forks for handling pallet loads. Read the manual of the attachment, e.g. manual of the bucket, for further information for safe and correct use. Observe the lift capacity rating of the loader when planning material handling operations.

The loader is not intended for lifting operations; never put slings, chains, or ropes on the loader boom.

## Handling of heavy loads



Carrying heavy loads can shift the centre of gravity of the loader and lead to tipping over of the loader. Always transport the load as low and close to the machine as possible to keep the centre of gravity low and for the best stability.

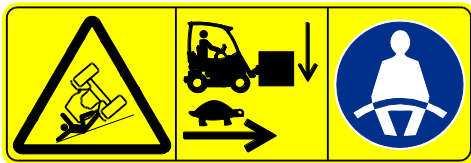

**WARNING:** Risk of rolling over - Keep loads close to ground, drive slow when carrying load.

Always use seat belt.



**WARNING:** Risk of tipping over (front direction) - Keep load close to ground, drive slowly.

Read operator's manual carefully.

### Whenever you handle heavy loads or heavy attachments:

- Handle heavy loads only on firm, level ground, while you drive slowly with the machine.
  - Uneven or inclined terrain significantly reduces the safe working load, (see also page 32).
  - Use the maximum loads indicated in the diagram in this manual as a guideline.
  - All rated operating capacities are based on the criteria of the machine is level on a firm supporting ground. When the machine is operated in conditions that deviate from these criteria (e.g. on soft or uneven ground, on a slope or when subject to slide loads), these conditions shall be taken into account by the operator
  - Remember that the actual load carrying capacity varies greatly according to operating conditions and control manner.
- Keep the articulated frame of the loader in straight position when you lift heavy loads. If you turn the loader during load handling, the stability of the loader will decrease and it may overturn the machine.
- The use of extra wheel weights is recommended for the 200 series loaders to increase the stability of the loader.
- Make sure to follow the recommended tyre pressures.
- Pay attention that a heavy load or long distance between the loader and the centre of gravity of the load will affect the balance and handling of the loader.
- When estimating the lifting capacity of the loader, remember to take the weight of the attachment into account.



Loader can tip over when you leave the driver's seat. Always put the load down on the ground before leaving the driver's seat. Follow safe stopping procedure on page 46.

## Refuelling (220/225)

Check fuel level and fill the tank if necessary. It is recommended to add fuel before the fuel tank gets empty and keep the tank full to prevent condensation of water into the fuel tank.

Do not overfill the fuel tank. Leave room for the fuel to expand. Leave about 50 mm of empty space below the filling neck of the fuel tank.

If the tank gets empty, prime the fuel system by leaving the ignition key to ON position for one minute to allow fuel pump to cycle and prime system. Turn key switch OFF. Starting may take a longer time as the fuel lines fill with fuel.

### ***Risk of fire or explosion - Handle fuel with care***



- Always stop the engine and allow it to cool before refuelling.
- Refuel only in a well ventilated area.
- Do not overfill the fuel tank. Leave at least 50 mm below the neck of the fuel tank to avoid spilling of fuel.
- Avoid spilling fuel when refuelling. Should this happen, wipe the fuel away immediately in order to avoid risk of fire.
- Keep fuel away from sources of ignition. Do not smoke during refuelling.

### **NOTICE**

Use only clean fuel and take care when refueling the loader to avoid dirt and water from entering the fuel tank. Clean fuel cap and surroundings before opening the cap. Always store fuel properly in an approved container. Water in fuel can cause severe damage to engine injection system.

Check fuel cap for damages and replace if necessary. A lockable fuel tank cap is also available from your Avant representative.

## Replacing a gas bottle (225LPG)

Change the gas bottle in a well ventilated place, preferably outdoors. Close the gas valve and let the engine run until it stops when gas is run out from gas piping to prevent leaking of gas.

The fuel level gauge is not in use in 225LPG. The weight of the gas bottle corresponds with the amount of gas in the bottle, so you can check if the gas bottle has gas by lifting it.

### **Risk of fire or explosion - Handle LPG gas with care**

**⚠ DANGER**



- Always stop the engine and allow it to cool before disconnecting gas bottle.
- Close the gas valve and let the engine run until it stops when gas is run out from gas piping.
- Change the gas bottle in a well ventilated place, preferably outdoors.
- Use only correct type of propane gas bottle which releases gas in vapor form.
- Check for leaks after tightening bottle fitting. Never start loader if you can smell or hear leaking gas.
- Do not change the bottle when the engine is hot, or in the vicinity of heat sources or ignition sources. Do not smoke during replacing of bottle.

**NOTICE**

**Keep all fittings clean.** Make sure that dirt or water cannot get into any fitting or hose. Wipe hose fittings clean and dry before disconnecting bottle. Dirt or water can cause the engine to stall or block filters prematurely.

**NOTICE**

Close the gas valve carefully, do not overtighten the valve. Do not open the valve more than necessary, typically max. 2-3 rounds, depending on gas bottle type. Gas bottle valve and the gas hose normally tighten when turning clockwise. See markings on the bottle valve.

**⚠ WARNING**

**To prevent gas leaks:**

- Tighten the gas hose securely to the bottle
- Make sure that threads match exactly between the hose connector and gas bottle
- Check for leaks after replacing the bottle, see page 77

***Make sure that threads of hose fitting match exactly those of the gas bottle***

Gas bottles in different countries and bottles made by various manufacturers may have different threading than the original hose and bottle. Make sure to follow correct opening and closing directions of the gas hose, some bottles may be threaded so that the hose fittings tighten when rotating counter-clockwise. Keep the amount of adapter fittings at a minimum. If more than one adapter fitting would be required, replace the LPG hose with a type that has correct fittings on both ends. See page 30 for information about fittings and types of gas bottles or contact your local Avant dealer.

## Transporting instructions and tie down points

Before transporting or lifting mount the articulation frame lock, see page 65. Lower the boom down and disconnect battery.

---

Remember to remove the frame lock after transport.

---

### Tie down points

There are a total of 4 tie down points:

Two on the front frame close to the boom:

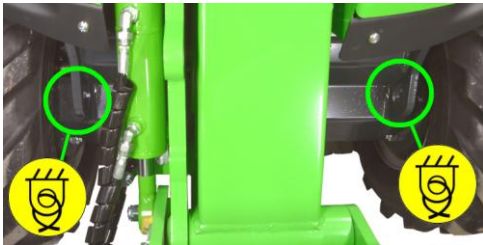

Two on the rear frame, near rear counterweight:

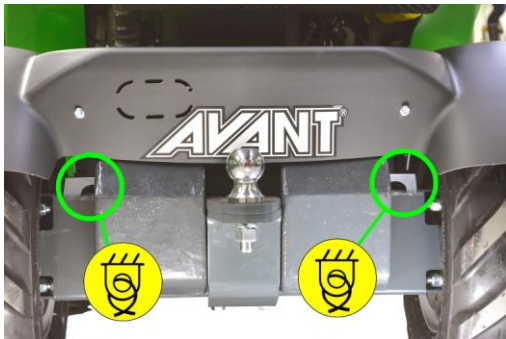

It may be necessary to tie down attachments separately. Make sure all equipment is secured also before just a short transport.

### Lifting

The loader can be lifted by mounting appropriate lifting slings on the ROPS frame. Lifting kit A418706 includes all necessary parts to lift the loader, contact your dealer.

Before lifting, heavy attachment and possible extra weights must be removed. Mount the frame lock on the machine.

Make sure that the lifting slings cannot move and that the machine doesn't swing during lifting. Loop the lifting straps around all four ROPS posts and make sure they are not tied or get damaged by e.g. sharp corners. Follow the instructions given in the operator's manual of the lifting slings. To lift a loader that is equipped with the Cab L, the front, side, and rear window panels must be removed first.

### **▲ WARNING**

Lower the boom and mount the articulation frame lock, see page 65. Remove any heavy attachment and extra counterweights before lifting. Never lift a loader with persons riding the machine.

### Towing (retrieval of the machine)

The hydrostatic drive system of the loader makes it impossible to tow the loader without special arrangements.

If absolutely necessary, the loader can be towed with a rigid tow bar, by releasing the hydraulic drive circuit. Maximum allowed towing speed is 3 km/h, and towing distance 200 m

### **▲ WARNING**

When the drive circuit is released for towing, the drive motors do not provide any braking force and the loader could start moving unexpectedly. Before releasing the drive circuit, make sure that the parking brake has been engaged, and release the parking brake only after a rigid tow bar has been connected.

## Storage

If outdoors storage is necessary, protect the machine with the designated weather cover (part no. 65435).

### NOTICE

Do not use the full, closed transport and weather cover over long periods of time as it promotes corrosion due to moisture that will condense inside it. The light weather cover can be used.

### **Preparing the engine for long term storage:**

If the engine will be out of service for 2 months or more, follow the procedure below

1. Add Kohler PRO Series fuel treatment or equivalent to fuel tank (Gasoline engines only). Run engine 2-3 minutes to get stabilised fuel into fuel system.

Alternatively, empty the fuel tank completely, start and run then engine until fuel lines and carburetors/injection system are completely drained and engine shuts down.

Old or stale fuel may cause the engine to not start after storage and may clog up the fuel system, requiring service. Effects of old fuel are not covered by the warranty.

2. Change engine oil while engine is still warm from operation. Remove spark plugs and pour about 20 ml of fresh engine oil into cylinders. Replace spark plugs and crank engine slowly to distribute oil. Do not use starter to crank the engine, severe engine damage may occur with oil in cylinders.

Alternatively, apply spray type vaseline through spark plug holes to protect cylinders.

3. Store loader in a clean, dry place.

See the engine owner's manual to prepare the engine for long term storage and how to start it after long storage period.

### **After storage:**

When taking the loader back to service after a long storage period:

1. If engine was prepared for storage with oil in cylinders, make sure to follow steps to drain the engine before operating the starter.
2. Perform daily inspections, (see "**Daily inspections**" on page 66).

## Storage of LPG gas

Store gas bottle in upright position with its protective cap fitted. Store the gas bottle preferably outdoors, in upright position. Keep gas bottle protected heat sources and from direct sunlight. Temperature at the storage area for the gas bottle must not rise above 40°C (104°F).

LPG gas is heavier than air and therefore bottles must not be stored in cellars or places, garages with a pit, or other areas where gas might accumulate.

Shut off tank valve. If possible, run engine on idle in a well-ventilated area until fuel system is empty and engine stops. If unable to run engine, work in a well-ventilated area and carefully loosen inlet fuel fitting on vaporizer/regulator, slowly venting off fuel from line. When fuel is dispensed, re-tighten fitting and remove quick connect fitting to allow fuel to escape from line.





# Working with attachments

## Requirements for attachments

Any attachment mounted on the loader must meet applicable safety and technical standards and requirements. An attachment that is not specifically designed for the loader may cause unsafe operation; make sure that Avant 220/225 is specifically listed in the operator's manual of the attachment. Some attachments may require the use of special protective guards or personal safety equipment.



- Read Operators Manual of the attachment before starting operation. Make sure that the attachment is compatible with the loader. Contact your Avant dealer if necessary.
- Make sure that the attachment is connected properly on the attachment coupling plate, and that it is being used in accordance with the instructions in the Operators Manual. Follow instructions regarding personal protective equipment and safety distances.
- Put the attachment down on the ground and stop the engine before leaving driver's seat. Familiarise yourself with the operation and stopping of the attachment at a safe place. Follow service instructions.

### NOTICE

Check max. allowed hydraulic oil flow for the attachment. Adjust engine revs so that they are suitable for the work and the attachment.

## Manuals of attachments



**DANGER**



**Attachments can create significant risks that are not covered by this Operator's manual of the loader.**

Make sure you have all attachments manual available. Wrong use of an attachment can cause serious injuries or death.

Each attachment is accompanied by its own respective Operator's Manual. The manual will show important information related to safety, and how to attach, use, and maintain each attachment correctly.

## Coupling the attachments

Attaching the attachment to the loader is quick and easy, but it must be done carefully. The attachment is mounted to the loader boom by using the quick attach plate on the loader boom and the counterpart on the attachment.

If the attachment is not locked to the loader, it may detach from the loader and cause a hazardous situation. The loader must not be driven and the boom must never be lifted when the attachment has not been locked. To prevent hazardous situations, always follow the coupling procedure shown below. Also remember the safety instructions shown in this manual. The attachment is mounted to the loader as follows:



Make sure that an unlocked attachment will not move or fall over. Do not stay in the area between the attachment and the loader. Mount the attachment only on level surface.



Never move or lift an attachment that has not been locked.



Always read also the additional instructions for coupling and using of the attachment in the Operator's Manual of the attachment.

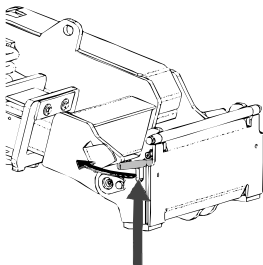

### Step 1:

- Lift the quick attach plate locking pins up and turn them backwards into the slot so that they are locked in the upper position.
- Ensure that the hydraulic hoses (and the electric harness, if applicable) are not in the way during installation.

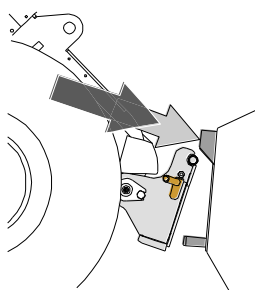

### Step 2:

- Turn the quick attach plate hydraulically to an obliquely forward position.
- Drive the loader onto the attachment.
- Align the upper pins of the loader's quick coupling plate so that they are under the corresponding brackets of the attachment.

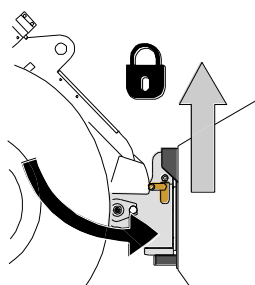

### Step 3:

- Lift the boom slightly – pull the boom control lever backward to raise the attachment off the ground.
- Turn the boom control lever left to turn the bottom section of the quick attach plate onto the attachment.
- Lock the locking pins manually.
- **Always check the locking of pins.**



**DANGER**

**Risk of falling objects - Prevent dropping of attachment**

- An attachment that has not been completely locked to the loader may fall on the boom or towards the operator, or fall under the loader during driving, causing loss of control of the loader. Never move or lift an attachment that has not been locked.
- Before moving or lifting the attachment, make sure that the locking pins are in the lower position and come through the fasteners on the attachment on both sides.

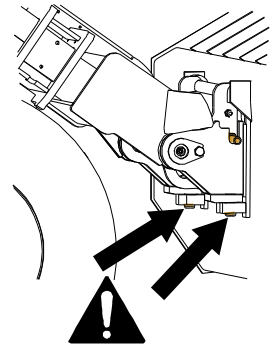

**Coupling adapters**

There are two adapter types to allow coupling of attachments that have smaller quick coupling plate (avant 200 series 1 attachments). Ensure the single quick coupling pin or the locking bolt is fastened securely.

**A35590 - Quick coupling adapter**

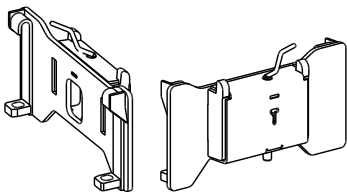

**A36825 - Bolt-on adapter**

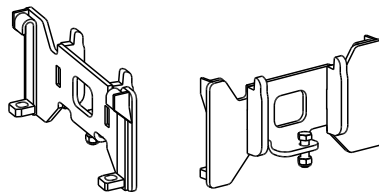

**CAUTION**

**Adapter plates reduce lifting capacity - Do not use adapters with heavy loads or attachments.** The adapter plates move the centre of gravity of the attachment further away from the loader. This increases the risk of tipping over and can limit the use of heavy attachments.

## Coupling the hydraulic hoses of the attachment

Hydraulic hoses of the attachment are equipped with the multi connector system, which connects all hoses at the same time.



### **WARNING**

Never connect or disconnect quick couplings or other hydraulic components while the control lever of the auxiliary hydraulics control lever is locked on or if the system is pressurized. Connecting or disconnecting the hydraulic couplings while the system is pressurized may lead to unintended movements of the attachment, or ejection of high-pressure fluid, which can cause serious injuries or burns. Follow safe stopping procedure before disconnecting hydraulics.

### **Connecting the multi connector system:**

1. Align the pins of the attachment connector with corresponding holes of the loader connector. The multi connector will not connect if the attachment connector is upside down.
2. Connect and lock the multi connector by turning the lever towards the loader.

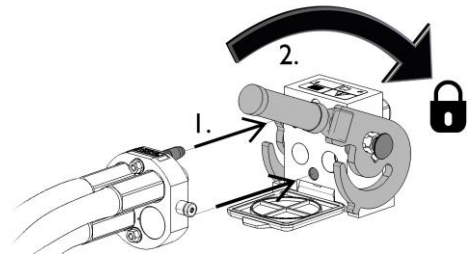

The lever should move easily all the way to its locking position. If the lever does not slide smoothly, check the alignment and position of the connector and clean the connectors. Also shut down the loader and release the residual hydraulic pressure.

### **To disconnect the multi connector system:**

Before disconnecting put the attachment down on a solid and even surface.

1. Switch off the auxiliary hydraulics of the loader.
2. While pushing unlock button, turn the lever to disconnect the connector.
3. After ending operation put the multi connector on its holder on the attachment.

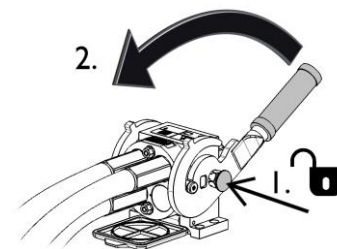

### **NOTICE**

Keep all fittings as clean as possible; use the protective caps on both the attachment and the loader. Dirt, ice, etc. may make using the fittings significantly more difficult. Never leave the hoses hanging on the ground; place the couplings onto the holder on the attachment.

### **NOTICE**

When fitting an attachment, make sure that the hydraulic hoses are not overstretched and are not in a position where they can be trapped during the operation of the machine and attachment.

## Using the auxiliary hydraulics

Auxiliary hydraulics (hydraulically operated attachments) are controlled with the lever on the control panel, or with the buttons on the 6 function joystick ( see page 36).

The locking position of the lever facilitates operation of the attachments that require constant oil flow (rotary broom, backhoe etc.). Make sure to release the lever when not operating an attachment to avoid loading the engine unnecessarily.



Going near an attachment that is in operation can cause a serious risk of injury. Switch off auxiliary hydraulics before leaving driver's seat or stopping the engine. Operate the controls only when sitting in the driver's seat.



The 2-way auxiliary hydraulics control lever ( see page 36) directs hydraulic as follows:

1. Moving towards the locking position will direct hydraulic flow to port 2. This is normally the normal or positive movement of the attachment.
2. Moving the lever away from the locking position will direct flow in reverse direction, pressure in port 1.
3. The third port is a free return line to tank, this is required by some attachments.
4. The 4<sup>th</sup> port is for the integrated electric socket of the optional Attachment control switch pack.

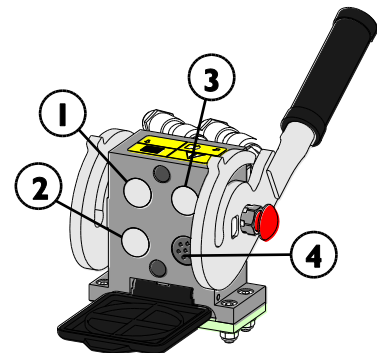

Overspeed of the attachment can cause injuries or dangerous movements of the attachment. The attachment can break down in a dangerous way, throw objects, or produce excessive noise and vibrations if operated at too high speed. Never exceed maximum allowed hydraulic flow of the attachment. Check correct operating flow from the operator's manuals of the attachment.



## **Releasing the residual pressure of hydraulic systems**

Make sure that there isn't pressure in the hydraulic system that could cause danger during service operations.C

To release the pressure in hydraulic system:

- Stop the engine and lower the boom down completely
- Move all control levers, including auxiliary hydraulics control lever, to their extreme end positions a couple of times
  - Move also control lever of rear hydraulics (if fitted)
- Keep in mind that the boom or attachment can move when releasing the pressure. Move the levers until all movements have stopped.

## **Rear auxiliary hydraulics coupling**

The rear hydraulics coupling is a double-acting hydraulic. The rear auxiliary hydraulics are controlled with their own lever, see pages 34 and 39 for further information.

Pair of standard type hydraulic quick couplings are located at the rear of the loader, just above rear weights.

- Before you connect or disconnect standard couplings, relieve hydraulic pressure as described in previous paragraph.
- To connect and disconnect the standard couplings, move the collar at the end of the female fitting.



- Note that the protective caps on the loader and the attachment can be fastened to each other during operation to reduce the accumulation of dirt.
- When disconnecting the standard quick couplings a small amount of oil may drip from the couplings. Wear protective gloves and have some cloth at hand to keep the equipment clean.

### **NOTICE**

Before you connect or disconnect the standard quick couplings, the residual pressure must be released as shown above. The conventional quick couplings will not connect, if there is pressure in the hydraulic system.

# Service and maintenance

To ensure long service life it is important to maintain the loader in good condition. Lack of maintenance will cause premature wear of the loader and can result in unsafe operation.

The maintenance procedures listed in this chapter can be performed by trained or otherwise experienced operators.

If the maintenance schedule is not followed, and services made are not marked in the table in this manual, the warranty may not cover for damages of the loader.

Service parts are available through your Avant dealer or authorised service.



If you are not sure about how to do any service operation, ask for additional information before starting servicing. Contact Avant service.

## Safety instructions



- Stop the engine and let it cool down before starting any service operation.
- Put the service support on the boom lift cylinder when working under the boom. Keep boom lowered otherwise.
- Install the frame lock when lifting the machine, and, for instance, when changing tyres.
- Before working on the engine or equipment, disconnect the battery.

### *Safe handling of hydraulic components*



**⚠ DANGER**

Never handle pressurised components. High-pressure ejection of fluid may penetrate skin and cause serious injuries. Before handling hydraulic components, make sure that the hydraulic system of the attachment and the loader are completely depressurised. Do not hold your hand near a fitting when tightening or opening it, and never use hands to search for leaks. If a leak is suspected, set a piece of cardboard to detect a leak.

Seek medical attention immediately in case hydraulic fluid is injected through the skin. Also skin contact with the oil can be harmful, wash hands thoroughly after contact with oil.



**⚠ WARNING**

Always wear protective gloves, safety goggles and protective clothing. Also skin contact with the oil can be harmful, wash hands thoroughly after contact with oil.



### Falling of load - Risk of crushing

#### **⚠ WARNING**

Always secure the loader boom with the provided service support, before going under the loader boom. Remove any load and attachments from the loader before service or maintenance.



#### **⚠ WARNING**

Check hydraulic hoses and components only when the engine is stopped and hydraulic pressure is released. Repair all leaks as soon as you have noticed them, because a small leak can quickly change into a big one.

Never operate the machine if you have noticed faults or leaks in hydraulic system. Leaking hydraulic fluid can cause serious personal injuries and is harmful to the environment.

#### **⚠ WARNING**

Check hydraulic hoses for eventual cracks and wear. Follow the wear of the hoses and stop operation if the outer layer of any hose has worn out. If there are signs of oil leakage, put a piece of cardboard under the probable leakage place in order to find the leakage. If you find fault, the hose or the component must be replaced. Contact your Avant dealer or service for spare parts.

### Consider the environment



The fluids in the machine are harmful to the environment. Never allow fluids to leak in the environment.

Take waste oil and fluids to recycling station. Find out about your local requirements concerning the recycling or disposal of other components.



## Installing of service support and frame lock

### *Installing boom service support:*

The red service support of the boom lift cylinder is stored under the boom.

Make sure that the boom stays up during maintenance operations by putting the service support on the lift cylinder piston rod. Secure the service support by locking it on the piston rod with a long screw or pin.

### **Service support stored under the boom**



### **Service support in place**



### **Frame lock:**

A red frame lock bar is stored near the drive pedals.

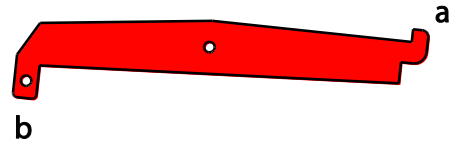

This lock bar is intended to lock the articulated frame to make the loader frame stay straight during e.g. lifting or transportation.

The holes for the frame lock bar are on the left side of the loader, one near the rear left wheel and another on the front frame, close to the articulation joint.

1. Slide the solid end (a) of the bar through a hole on the rear frame of the loader. Hold the other end of the bar tilted towards the right side of the loader.
2. Turn the holed end of the bar towards the left side of the loader. The other end should remain locked in the hole on the rear frame.
3. Align the other end of the bar (b) and the frames by turning the steering wheel, this can be done without running the engine. Once aligned, slide the bar and lock with its cotter pin.

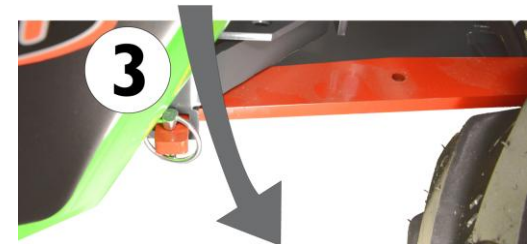
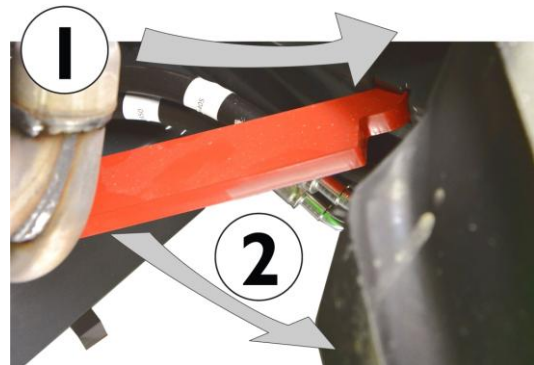

## Daily inspections

Do a walk-around check of the loader before each working shift. Check at least the following points and do not use the loader if you notice problems with any of the listed items.

Check before start		To check
1.	Tyre pressure	<ul style="list-style-type: none"> <li>▪ Check visually daily</li> <li>▪ Check with pressure gauge if wrong pressure is suspected, see page 29</li> </ul>
2.	Hydraulic oil level	<ul style="list-style-type: none"> <li>▪ Check level of hydraulic oil especially after using a new attachment that drains hydraulic oil from the loader as the hydraulic system of the attachment fills up. Check also if a leak is detected.</li> </ul>
3.	Need for lubrication	<ul style="list-style-type: none"> <li>▪ Make sure all joints are lubricated sufficiently, see page 68</li> </ul>
4.	Cleanliness of engine compartment and radiators	<ul style="list-style-type: none"> <li>▪ Keep engine area clean to prevent engine from overheating</li> <li>▪ Check and clean engine cooling areas, air intake areas and external surfaces of engine (particularly after storage)</li> <li>▪ Dust, hay, and dry materials on and around the engine will cause a fire hazard</li> </ul>
5.	Oil or fuel leakages	<ul style="list-style-type: none"> <li>▪ Check the underside of the loader. Also check ground/floor surface for signs of leakage</li> <li>▪ Never operate if leakage is observed. Repair before use</li> </ul>
6.	General condition of the loader	<ul style="list-style-type: none"> <li>▪ Check for damages on metal parts or rust</li> <li>▪ Ensure all safety decals are in place and legible</li> </ul>
7.	Condition of the safety frame, seat belt, lamps, and other safety equipment	<ul style="list-style-type: none"> <li>▪ Safety frame (ROPS) and protective roof (FOPS) must be fitted</li> <li>▪ Safety structures must not have visible damage or deformations. They must be replaced after any incident</li> <li>▪ Make sure all lamps are functional and clean</li> </ul>
8.	Attachment and its locking	<ul style="list-style-type: none"> <li>▪ Locking of attachment and locking pins on attachment coupling plate</li> <li>▪ Function of attachment, position of attachment hoses</li> <li>▪ See also the operator's manual of the attachment, see page 5</li> </ul>
9.	Exhaust pipe and spark arrestor (if equipped)	<ul style="list-style-type: none"> <li>▪ Check that no combustible material is in contact with exhaust pipe or muffler</li> <li>▪ If spark arrestor is fitted, check its condition and installation</li> </ul>
Check after starting the engine		
10.	Drive control and steering	<ul style="list-style-type: none"> <li>▪ Check operation of pedals and steering after start. Pedals must move freely and not get stuck or feel stiff</li> <li>▪ Check that loader stops when not pressing the drive pedals. Do not use the loader if braking performance is decreased or if the loader creeps</li> <li>▪ Allow the loader to warm up and check steering</li> </ul>
11.	Boom movements	<ul style="list-style-type: none"> <li>▪ Boom should move smoothly to all extreme positions when using without an attachment</li> <li>▪ If attachment is fitted, check that the boom moves smoothly within its normal operating range</li> <li>▪ Hydraulic hoses or electric cables must not get pinched or stretched in any position of the boom</li> </ul>

## Maintenance schedule

Following tables show the maintenance and service points and intervals for the loader and its engine. There are more detailed instructions about each service operation, in numerical order, on the following pages.

Part A - Loader		Every week	After first 50 h	Every 200h / year
1	Clean the machine	●	■	■
2	Grease the machine	●	●	●
3	Check tyre pressure	●	-	-
4	Check tightness of bolts, nuts and hydraulic fittings	■	●	●
5	Battery check	●	●	●
6	Check hydraulic oil level	●	-	-
7	Change hydraulic oil filters	-	●	●
8	Change hydraulic oil	-	●	●
9	Check pressure of hydraulic system	-	●	●
10	Adjust pressure of hydraulic system	-	■	■

Part B - Engine		Daily / Every 10 h	Every week	After first 50 h	Every 200 h / year
1	Clean air filter element	■	●	-	-
	Replace air filter element	-	■	■	●
2	Check engine oil level	●	●	-	-
3	Change engine oil	-	-	●	●
4	Change engine oil filter	-	-	●	●
5	Clean engine oil cooler	■	●	-	-
6	Change fuel filters	-	-	●	●
7	Check fuel lines	-	-	●	●
8	Check / clean cooling fan	■	●	-	●
9	Check condition and tightness of pump drive belt	-	-	●	●

- Maintenance operation
- When necessary

## Loader maintenance

### 1. Cleaning of the machine

Cleanliness of the loader is not only a question of outer appearance. All surfaces, painted and others, will stay in better condition when they are cleaned regularly. A dirty machine will run hotter and will collect more dirt into the air cleaner, which may shorten the engine life.

Pay special attention to the cleanliness of the engine, the engine compartment, the radiators, the hydraulic pump compartment, hydraulic quick couplings and the oil tank cover.

The outer surfaces of the loader can be carefully washed with a pressure washer. However, avoid direct spraying on hydraulic components (hoses, cylinders), any electric component, decals, and the radiators.

Clean cab interior with appropriate mild detergent and cleaning supplies.

After washing grease all greasing points.

#### **NOTICE**

The loader is equipped with a hydraulic oil cooler, which is located at the rear of the loader, behind the driver's seat. Make sure to clean the oil cooler cell with compressed air every time you are servicing the loader - and even more frequently if the loader is being used in dusty conditions.

### 2. Greasing of the machine

Greasing of pivot points is very important in order to avoid wear. Most of the greasing points are on the loader boom. The following pictures show the location of grease nipples.

Following pictures show the location of greasing points.

#### **1. Lift cylinder, both ends**

**2**

(lower end accessible from the driver's seat side through a hole below the steering wheel)



- 2. *Levelling bar, both ends* 2
- 3. *Tilt cylinder, both ends* 2



- 4. *Pivot pin on attachment coupling plate/boom* 3

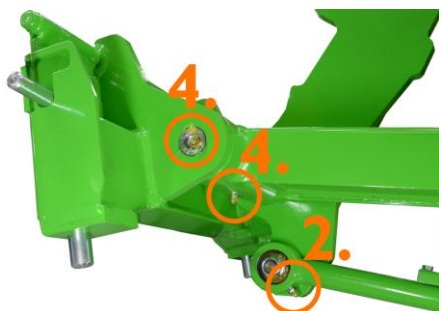

- 5. *Pivot pin on loader boom* 1
- 6. *Steering cylinder, both ends* 2



- 7. *Articulation joint* 2

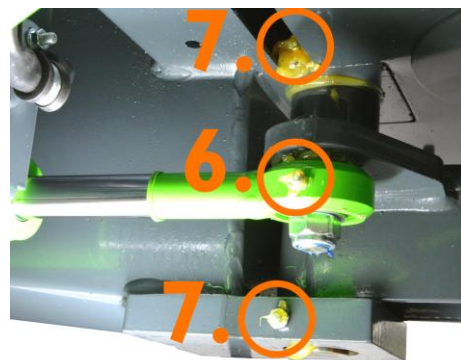

### **3. Tyre pressure check**

Check tyre pressure when heavy attachments and extra counterweights are not attached. Correct tyre pressure depends on intended load. Refer to Chapter Technical Specifications.

### **4. Check and tightening of bolts, nuts and fittings**

Check tightness of bolts, nuts and hydraulic fittings regularly. However, do not overtighten; tighten hydraulic fittings only if necessary.

Wheel nuts should be tightened 150 Nm.

Check the tightness of the pivot pin locking screws, if loose tighten and use thread locker.

**NOTICE** Tighten wheel nuts after first 5 operating hours. Check tightness of wheel nuts regularly.

### **5. Battery check**

**WARNING** Before handling the battery, see safety instructions about handling the battery on page 15.

The battery is located under a cover plate, under the left side of floor of the loader.

Open the two screws of the cover to access the battery.



### NOTICE

Disconnect the battery from the disconnect switch first.

Clean the surroundings of the battery carefully. Remove also dirt from under the battery.

Inspect and clean battery terminals regularly. Check also condition and fastening of battery cables and terminal insulators. Make sure that battery cables cannot chafe against any sharp edges. Check also condition and fastening of battery disconnect switch and cables.



The battery is sealed and maintenance free, meaning that it doesn't need and can't be refilled with water during its lifetime. Do not attempt to open the cover of the battery.

Before long term storage of the loader, remove the battery and store it in cool, well ventilated area and charge every few months. Keep the battery charged to prevent it from freezing. Never charge a frozen battery.

Replace battery with a battery that meets the original specifications. Handle batteries with care and recycle used batteries.

## 6. Hydraulic oil level

Hydraulic oil level can be checked with the dipstick in the filler.

Oil level should be at the lower mark of the dipstick when the loader boom is up. Refill when necessary. Do not let any contaminants enter the hydraulic oil tank during this procedure. There is a breather filter inside the dipstick cap which should be cleaned or changed once a year.

## 7. Hydraulic oil change

When changing hydraulic oil, the oil can be removed with a suction pump or by opening the drain plug on the right side of the front frame, next to the articulation joint. In both cases it is important to clean the magnetic drain plug. Hydraulic oil tank capacity is 23 l.

## Hydraulic oil type

Always use correct type of clean, high quality ISO VG-46 certified mineral hydraulic oil. If ambient temperature is hot, higher viscosity oil may be required, contact dealer.

In freezing temperatures use oil designed for the purpose, in order that the machine operates as intended and starting is easier.

### NOTICE

Use of synthetic or bio hydraulic fluids may cause premature wear or damage to the hydraulic components and is not permitted. Using wrong type of hydraulic oil will void the warranty.

## 8. Changing of hydraulic oil filters

### *The hydraulic oil return filter:*

- Located on top of the hydraulic tank, under the cover front cover. Take off the cover and replace the oil filter cartridge.



**The hydraulic pressure filter:**

- Located at the right side of the loader, beside the hydraulic pumps. Use general filter replacement tool to unscrew the filter.



## 9. Check pressure of hydraulic system

Pressure checking points and pressure settings for different functions are listed below.

It is recommended to leave the checking operation to qualified service technicians. At minimum, a hydraulic pressure gauge with appropriate measurement scale and a measurement fitting is required.



**Risk of injection of hydraulic oil**  
**- Wrong handling of the hydraulic system or wrong tools can cause ejection of hydraulic oil.** It is recommended that pressures should only be checked or adjusted by a competent and experienced technician. Contact your AVANT dealer if you need assistance.



**Boom lifting pressure:**

Pressure is checked from the manometer fitting mounted on the main control valve, and shown in the picture above.

Pressure is measured with full engine revs and by turning e.g. the bucket tilt control to end position. Pressure setting should be 20,0 MPa (200 bar).

**Auxiliary hydraulics pressure:**

Pressure is checked from the auxiliary hydraulics outlet with full revs and by turning the aux. hydraulics control lever.

Pressure setting should be 20,0 MPa (200 bar).

**Drive pressure:**

In order to check the pressure in the drive circuit one needs to mount a pressure gauge in the pressure line in each and every case, if pressure seems to be clearly wrong. There are two pressure relief cartridges which have fixed 28,0 MPa (280 bar) pressure setting.

## 10. Adjust pressure of hydraulic system

If the pressure of hydraulic system does not seem to be correct or pressure check indicates that the pressure is wrong, it can be adjusted.

Adjust the pressure with an allen key, max. 1/8 rounds at a time. See pictures for pressure adjustment points.

**⚠ DANGER**

Never exceed the recommended hydraulic pressure settings. Excessive hydraulic pressure may lead to hydraulic oil ejection by hose burst or component failure. Wrong adjustment will damage or wear the hydraulic pumps, cylinders, and hydraulic motors. Warranty does not cover damages caused by excessive hydraulic pressure.

**Boom pressure adjustment:**

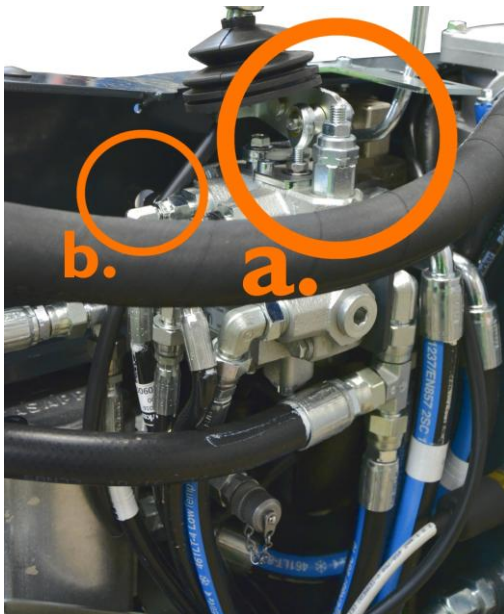

Boom pressures adjusted from the pressure relief valve **a** at the main control valve.

Adjust by turning the screw incrementally and lock by tightening the locking nut.

Pressure relief valve **b**, shown in the picture above, is an internal control valve which does not affect boom cylinder pressures. Its adjustment is allowed only to authorised service.

**Auxiliary hydraulics:**



Auxiliary hydraulics system pressure is adjusted from the pressure relief valve of the aux hydraulics control valve.

Pressure adjustment screw is locked with a nut, loosen the nut first.

Adjust by turning the screw incrementally through a hole on the metal panel.

**Drive pressure:**

Can not be adjusted by user. If the pressures are clearly wrong, the pressure relief cartridges with 28,0 MPa (280 bar) bar fixed pressure setting must be replaced.



## Engine maintenance

### Engine service

AVANT 200 series loaders are equipped with a gasoline or LPG Kohler engine. Further and more detailed service and maintenance instructions for the engine can be found in the Kohler Operator's Manual supplied with the loader.

### 1. Air filter element

Before opening the filter cover, wipe the outer surface of the air filter housing clean. Clean also the inner components of the filter housing with a damp cloth. **Never use compressed air to clean the filter!**

When reinstalling the cartridge, ensure proper tightness and sealing of the filter and the housing cover.

#### Air filter, 220:

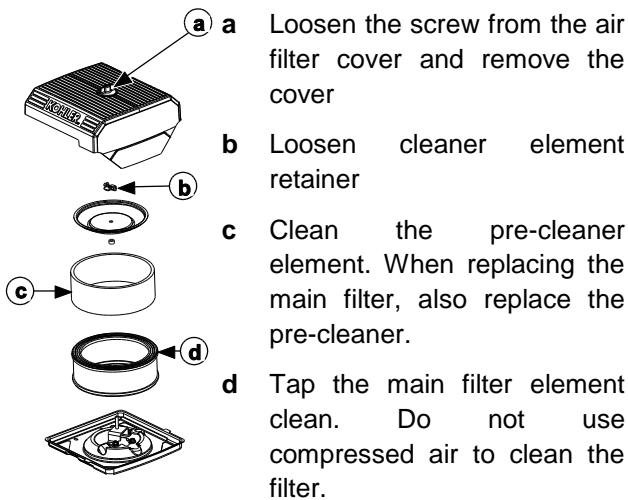

Clean the filter housing.

#### Air filter, 225:

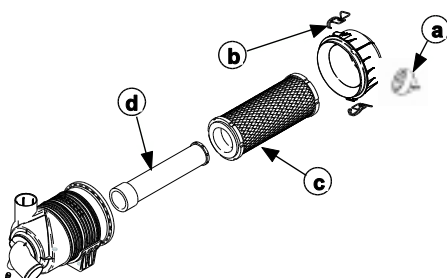

- a** Squeeze the dust cap to drain water and collected dust.
- b** Open the two clips of the air filter cover and pull the cover out.
- c** The main filter cartridge can then be pulled out. To clean the filter, tap the closed end of the filter gently against a flat, clean surface.
- d** Leave the inner element in place. Replace only when necessary.

### 2. Check engine oil level

Check engine oil when the engine is not running and loader is on flat, level ground.

Oil dipstick is located under the seat, next to the battery disconnect switch. The cap of the dipstick / filling opening is marked yellow. Clean oil fill / dipstick areas of any debris.

Check that oil level is between upper and lower marks when engine is on flat ground:

1. Remove dipstick; wipe oil off.
2. Reinsert dipstick into tube; rest cap on tube, do not thread cap onto tube.
3. Remove dipstick; check oil level. Level should be at or below top of indicator on dipstick.
4. If oil is low on indicator, add oil up to top of indicator mark.
5. Reinstall and secure dipstick.

#### NOTICE

Never add too much oil in the engine - severe engine damage may result. Excessive oil may also cause heavy emissions and thick exhaust smoke. In case of overfill, drain some oil from the engine.

### 3. Change engine oil

Change oil while engine is warm. Engine oil can be drained to a suitable container from the hose shown in picture below.



#### **4. Change engine oil filter**

Engine oil filter is located on the right hand side of the machine, and can be seen from the engine compartment.



#### **5. Engine oil cooler**

Fitted on the right side of the engine, there is an engine oil cooler. The cooler must be cleaned regularly, and if operating in dusty conditions, check the cleanliness of the cooler daily.

##### ***To clean the cooler:***

1. Clean fins with a brush or compressed air.
2. Remove two screws securing oil cooler (upper screw shown), and tilt to clean back side.
3. Reinstall oil cooler.



#### **6. Fuel filters**

##### ***Fuel filters - 220 225***

The fuel lines run through a filter by the engine.



Care must be taken when replacing the fuel filter. Make sure to keep all parts clean during service. Service only cold engine. In demanding operating environment the fuel filter must be changed more frequently than the recommended maintenance interval.

##### ***Fuel filter (225LPG)***

There are two filters in the LPG system

- 30 µm button filter in pressure regulator
- 10 µm LPG EFI filter

See engine owners manual for replacement instructions.

#### **7. Check fuel lines**

##### ***220 / 225:***

Check all fuel lines and hose clamps for signs of wear or damage. In case a fuel hose needs to be replaced, replace all hoses and clamps at the same time.

Check fuel tank externally. Check for abrasions, signs of deformation, or other wear that makes it necessary to replace the fuel tank with a new one. Check also the fuel cap.

Use only original type of fuel cap. Lockable cap is also available.

##### ***225LPG***

Check the fuel hose connected to LPG cylinder every time when changing the LPG cylinder. Use a high quality LPG hose that fulfils the same standards as the original hose and is intended to be used with LPG at working pressures.

Replace the hose immediately if you see cracks or abrasions on the outer surface of the hose. Park the loader protected from direct sunlight to prolong the service life of the hose.

Local regulations or operating conditions may require to replace the hose periodically, ie. each year or after two years. Also, follow the marked expiration date on the hose (if hose is marked).

Whenever loosening any LPG related fitting, do a leak test as described on page 77.

### 8. Check / clean engine cooling fan

The engine cooling fan, located on top of the engine, must be kept clean to avoid engine overheating and damage. Check the grill on top the engine visually, if dirt is visible, clean the fan. Follow instructions in the operator's manual of the engine.

In demanding operating conditions the cooling fan must be checked more often.

#### NOTICE

Proper cooling is essential. To prevent overheating, clean screens, cooling fins, and other external surfaces of engine. Avoid spraying water at wiring harness or any electrical components.

### 9. Drive belt

AVANT 220/225 loaders are equipped with a drive belt which connects the hydraulic pumps to the engine. The belt may get loose over a long period of time and may need tightening.

There is a hole in the bottom of the loader for checking the tightness of the drive belt. Belt is correctly tightened when it moves in the middle of the hole 9 mm when 70 N force is applied (See picture).

Belt tightening device increases tension of the drive belt (pulls the pump away from the engine) when the two screws on the right are being tightened. Loosening of these screws reduces tension of the drive belt.

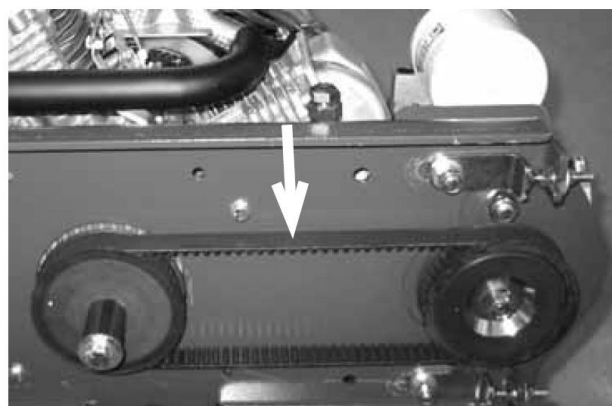

#### NOTICE

If the belt is too tight it gives a whistling noise. Loosen the belt without delay because a stretched out belt can get damaged or cause damage to the hydraulic pump.



Engine must be stopped before checking the drive belt.

### Filters - list of filters

In order to receive regular service parts easily, you can order the following service packages from your dealer. For 225LPG parts, contact your dealer or service point.

Filter kit A46683 Avant 220	
Fuel filter	64827
Air filter	64825
Engine oil filter	64824
Hydraulic oil pressure filter	64807
Hydraulic oil return filter	74093
Spark plugs, 2 pcs	64828

Filter kit A420536 Avant 225EFI	
Fuel filter	66260
Air filter	66258
Engine oil filter	64824
Hydraulic oil pressure filter	64807
Hydraulic oil return filter	74093
Spark plugs, 2 pcs	66261

## Fuel system, gasoline 220/225

### 225 EFI (EPA and CARB compliant)

Low permeation fuel line must be installed on carbureted Kohler Co. engines to maintain US EPA and CARB regulatory compliance.

For full details, consult authorised service.

#### A. Low permeability fuel tank assembly

1. Low permeability gasoline fuel tank
2. Sealed fuel tank cap
3. Fuel level sensor
4. Fuel lines
5. Fuel filter
6. Carbon canister
7. Tank breather valve

#### B. EFI fuel supply to engine

8. Hose to purge valve on engine
9. Pulse type fuel pump
10. EFI fuel pump
11. High pressure fuel hose
12. Gasoline fuel injectors
13. Fuel pump hose

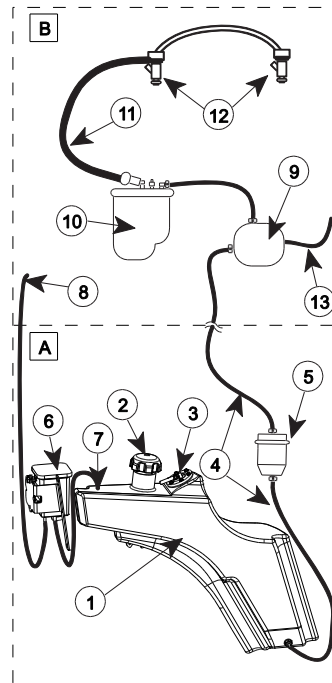

## Fuel system, 225LPG

### A. Vapor draw propane cylinder

1. Propane in liquid form inside cylinder
2. Vaporised propane
3. Fitting(s) for propane hose
4. Shielded propane vapor pick-up  
*Depending on propane cylinder type and availability. Shielded type recommended.*
5. Manual shut-off valve & overpressure relief valve
6. LPG hose

### B. LPG fuel supply to engine

7. 30 µm filter
8. Pressure regulator
9. Electronic shut-off valve
10. 10 µm propane EFI filter
11. Vapor LPG fuel injectors

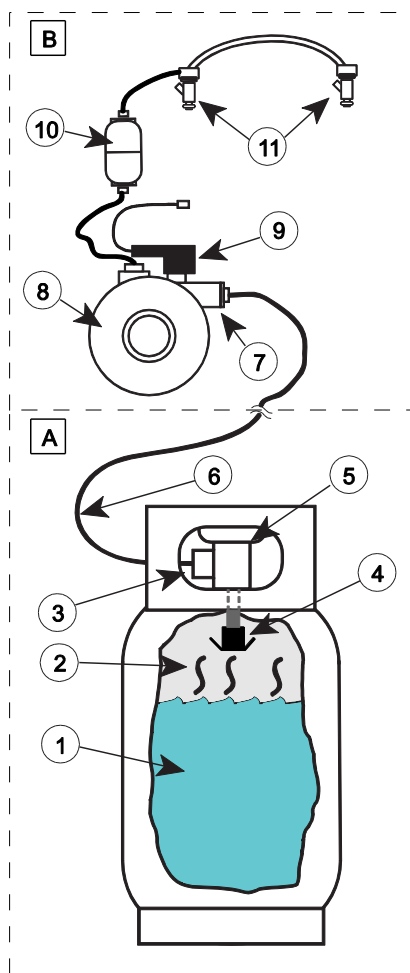

## LPG system maintenance

Over time, depending on fuel quality, operating environment, and system performance, fuel deposits can accumulate inside pressure regulator. See the operator's manual of the engine for instructions to remove any accumulated deposits.

The regulator is pre-adjusted at factory and must not be opened or adjusted to comply with emissions and safety standards. All other service than described above related to regulator or the EFI system must be performed by authorised service only.

### Check for leaks

If a gaseous odour is detected, close LPG bottle valve, turn off loader main switch, and ventilate area. Find out cause for gas odour before attempting to restart. To ensure personal safety, installation and repair of propane fuel supply systems must be performed only by qualified service technicians, contact Avant service.

LPG is usually perfumed, in order that gas smell can be recognised. Because of the perfume the gas smells somewhat also in normal use especially when running a cold loader engine, and when the engine is under high load. If the gas smell is strong, do not start the engine. Find out the reason for the gas leak.

Use soap water to check all connectors and hoses to check for leaks. Sophisticated leak indication solution or gas detecting equipment can also be used. Apply plenty of soapy water or other solution on all fittings after tightening. After you open the gas bottle valve, check if leaking gas causes bubbles to appear. Move the gas hose around a little to make sure that all fittings are tight. Close the gas bottle and wipe the fittings clean after test.

## **Engine Malfunction indicator light (225 / 225LPG only)**

In case the ECU has detected a fault requiring immediate service, the Malfunction Indicator Light lights up on the multi-function display. The engine may be set to fault mode, including reduction of engine output. If necessary, the loader can be driven to a safe location, but must not be loaded or used more than absolutely necessary. Engine must be checked and serviced by authorised service before continuing use.

### **Diagnostics fault codes**

The MIL light can also be used to display fault codes stored by the ECU. To read the fault code:

1. Turn key switch to ON and OFF, then again ON and OFF, then ON, leaving it on in third sequence. Do not start engine. Time between sequences must be less than 2.5 seconds.
2. MIL will blink a series of times. Number of times MIL blinks represents a number in blink code.
3. A sequence of four digits make up a fault code. There is a one (1) second pause between blinks of a fault code. There is a three (3) second pause between separate fault codes. After fault code(s) are blinked a two digit 61 is blinked to indicate programme has completed.
  - It's a good idea to write down codes as they appear, as they may not be in numerical sequence.
  - Code 61 will always be last code displayed, indicating end of code transmission. If code 61 appears immediately, no other fault codes are present.

Fault codes may help diagnosing a problem when communicating with authorised service. Interpretation of fault codes and MIL reset require contact with service.

## **Electric system & fuses**

In the event of electric malfunction, always check the fuses first. If fuse is blown repeatedly, search for cause of burning fuse. Electric cables may be damaged. Contact service.

Avant Avant 220/225/225LPG is equipped with separate fuse boxes:

### **Main fuse box**

Located near the left knee area.



	15 A	Turning signal Front/rear lights Beacon
	10 A	12 V outlet
	15 A	Horn Seat heater
	10 A	Hydraulic oil cooler
	15 A	Work lights Road traffic headlights Windscreen wiper/washer
	25 A	Joystick Attachment control switch pack

**Engine fuses**

Engine main fuse is located on the left side of engine compartment, near battery disconnect switch:



**Hydraulic oil cooler fan fuse**

The red indicator on the dashboard indicates blown hydraulic oil cooler fan fuse. If the indicator is lit, check the 10 A fuse of the oil cooler fan. Check the cooler fan can rotate freely and is not blocked. Contact Avant service if necessary.

**Jump start and auxiliary power**

The engine can be started with auxiliary power if necessary, by using appropriate (strong enough) jump start cables that are connected to the battery. Alternatively, a separate start booster with its internal battery can be used, refer to its instructions about correct use.

Connect first one end of the positive cable to the positive (+) post of the dead battery. Then connect the other end of the positive jumper cable to the positive (+) post of the charged battery. Connect one end of the negative jumper cable to the negative (-) post of the charged battery. Then connect the other end of the negative jumper cable to a solid, non-paint coated metal part of the engine of the dead loader, as far from the dead battery as possible.



Never bypass battery or connect cables directly to starter motor. Serious injury may occur due to moving of the engine components or loader. Also, engine may get damaged.



Read Operator's Manual of the vehicle that is giving auxiliary power, in order to make sure that the vehicle suited for the purpose. The vehicle can get damaged when giving auxiliary starting power.

**Light bulbs**

- |    |                          |          |
|----|--------------------------|----------|
| 1. | Front lights             | LED unit |
| 2. | Work lights              | LED unit |
| 3. | Road traffic headlights: | H7       |

**Metal structures of the loader**



Contact Avant service in case the steel structure of the loader gets damaged. A faulty reparation, or wrong methods and materials used for reparation, can cause hazardous failures or further damage the loader.



In case the ROPS safety frame or the FOPS canopy of the machine gets damaged, the machine must be taken to Avant service for checking. It is not allowed to repair the ROPS and FOPS.

# Troubleshoot

Listed below are possible causes for typical problems. Further engine related causes can be found in the operator's manual of the engine. In case there is trouble with the operation of the machine, check both troubleshoot lists and if problem is not solved, contact your nearest service point.

Problem	Possible cause	Remedy
Engine does not start	Battery switch in off position	Turn battery switch to on position
	Blown fuse	Check all fuses
	Battery empty or damaged	Charge battery or start with separate battery. Check battery condition, replace if necessary.
	No fuel	Fill the tank or replace gas bottle
	Auxiliary hydraulics control lever is in locking position	Release the lever to neutral position.
	Choke not used or choke not working	Use choke when cold starting (220 only). Check choke cable.
	Old fuel or water in fuel (220/225 only)	Gasoline fuel gets stale after being stored for a couple of months. Drain fuel tank and add fresh fuel. If new fuel does not help, carburetors or injection system may have to be cleaned, contact service. Prevent by adding fuel preserver before storage.
	Cold ambient temperature	Use engine pre-heater (optional equipment). Use high quality multi grade engine oil. 225LPG: <i>see below</i>
	Low engine oil level	Engine oil level switch prevents starting, check oil level and add engine oil if necessary.
Engine does not start or runs poorly (225LPG only)	LPG bottle valve closed or not fully open (225LPG only)	Open the manual valve of the gas bottle fully. Depending on bottle type, turning by more than 1 round may be needed. Restricted flow may cause valve to freeze internally, allow the fuel system to warm up.  Check hose connectors and hoses, hose must not be bent.
	LPG operated in too cold environment (225 only)	The LPG is drawn from the bottle in vapor form. Propane will cool the bottle and the regulator can freeze or bottle pressure drop. Allow the bottle to warm, never heat with external heat source.  Check that propane LPG with minimal amount of butane is used.
	LPG bottle has cooled too much during use	Vaporising gas draws heat from ambient air. Pressure of LPG gas depends on temperature. Once the bottle is too cold, no more gas is vaporised and the bottle must be allowed to slowly warm up. The bottle will feel cold to the hand and can also have condensed water or frost on its outer surfaces.
	Wrong type of LPG bottle (225LPG)	Use only vapor type propane bottle in vertical position. Liquid draw bottle will not work, even though engine might start momentarily.



Problem	Possible cause	Remedy
Hydraulic attachment does not work when the auxiliary hydraulics control lever is moved	Attachment hoses are not coupled or the multi connector is not fully locked	Make sure that the multi connector is properly connected.
	Faulty or damaged quick couplers (will restrict or stop oil flow)	Replace quick couplers in multi connector.
	Fault in attachment	Check with another attachment, if possible.
Attachment hoses will not go into the rear quick couplers of the machine	There is back pressure in the auxiliary hydraulics line	Release the pressure by moving the rear auxiliary hydraulics control lever in both directions.
Hydraulic oil overheats	Control valve not fully open	Adjust the locking plate of the aux hydraulics control lever, see page 36.
	Low hydraulic oil level	Check hydraulic oil level and condition.
	Dirty, blocked or faulty hydraulic oil cooler	Clean hydraulic oil cooler, check fan. Check fan fuse, temperature switch, and relay.
	Overload of hydraulic system	Allow to loader cool by leaving on idle, until hydraulic oil cooler stops. Avoid operating an attachment at extreme load continuously. Check that attachment is operated correctly, and no flow restrictors are left half open on hydraulic circuit.
The machine moves after parking brake has been engaged	The pins of the parking brake mechanism have not locked properly in the wheels	Drive slowly forward or backward in order to lock the parking brake. When releasing the parking brake do this in opposite order.
Drive and boom movements do not work at all, engine is running	Drive belt damaged	Check condition and tightness of drive belt.
Drive works erratically and boom movements do not work at all, engine is running	Low hydraulic oil level	Check hydraulic oil level and condition.
Drive and boom movements work erratically, engine is running	Air in hydraulic components	Move boom and steering cylinders and hold at each extreme position to de-air the system. Check hydraulic oil level and condition.
Hydraulic oil pushed out from hydraulic oil filler cap, hydraulic oil foams	Leak in hydraulic suction line connecting tank and hydraulic pumps allows air to sucked in	Replace suction hoses.
Thick exhaust smoke	Too much engine oil	Check engine oil level, drain if necessary.
	Rich mixture	Choke is being used, turn off choke. Carburettor setting is wrong, adjustment required. Contact service.
	Faulty carburettor	Carburettors overflow, allowing gasoline flow to engine oil (220 only). Check carburettors, contact service.
	Oil in cylinders	Worn piston rings or valve gaskets, engine overhaul required

# Services made

1. Customer \_\_\_\_\_
2. Loader model \_\_\_\_\_ Serial number \_\_\_\_\_
3. Date of delivery \_\_\_\_\_

Date of service dd / mm / yyyy	Operating hours	Remarks	Serviced by: Stamp/signature
___/___/____	____/ 50 h		
___/___/____	____/ 250 h		
___/___/____	____/ 450 h		
___/___/____	____/ 650 h		
___/___/____	____/ 850 h		
___/___/____	____/ 1050 h		
___/___/____	____/ 1250 h		
___/___/____	____/ 1450 h		
___/___/____	____/ 1650 h		
___/___/____	____/ 1850 h		
___/___/____	____/ 2050 h		



EC DECLARATION OF CONFORMITY	DÉCLARATION DE CONFORMITÉ CE	EG-KONFORMITÄTS-ERKLÄRUNG
Manufacturer: Avant Tecno Oy Ylötie 1 33470 Ylöjärvi, Finland	Fabricant : Avant Tecno Oy Ylötie 1 33470 Ylöjärvi, Finlande	Hersteller: Avant Tecno Oy: Ylötie 1 33470 Ylöjärvi, Finnland
Technical Construction File Location: Same as Manufacturer	Emplacement du fichier technique de fabrication : Le même que celui du fabricant	Ort der technischen Bauunterlagen: Identisch mit Hersteller
We hereby declare that the machine listed below conforms to EC Directives: 2006/42/EC (Machinery), 2014/30/EC (EMC) and 2000/14/EC (Noise Emission).	Nous déclarons par la présente que la machine mentionnée ci-après est conforme aux directives CE: 2006/42/CE (machines), 2014/30/CE (CEM) et 2000/14/CE (émission de bruit)	Wir erklären hiermit, dass die nachstehend aufgeführte Maschine mit folgenden EG-Richtlinien in Übereinstimmung steht: 2006/42/EG (Maschinenbau), 2014/30/EG (EMV) und 2000/14/EG (Lärmemissionen).
Category: EARTH-MOVING MACHINERY / LOADERS / COMPACT LOADERS	Catégorie : ENGINES DE TERRASSEMENT/ CHARGEURS/ CHARGEURS COMPACTS	Kategorie: ERDBEWEGUNGSGERÄT/ LADER/KOMPAKTLADER

Model / Modèle / Modell:  AVANT 220  AVANT 225  AVANT 225LPG  L

Serial Number / Numéro de série / Seriennummer:

Year of manufacture / Année de fabrication / Baujahr: **2016-2017**

Directive Directive Richtlinie	Conformity Assessment Procedure Procédure d'évaluation de conformité Konformitätsbewertungsverfahren	Notified body Organisme notifié Zugelassene Stelle
2006/42/EC	Self-certification	----
2006/42/CE	Autocertification	
2006/42/EG	Selbstzertifizierung	
2014/30/EC	Self-certification	----
2014/30/CE	Autocertification	
2014/30/EG	Selbstzertifizierung	
2000/14/EC	Type-test	Natural Resources Institute Finland, Measurement and Standardization (Luke Vakola) <b>NB 0504</b> Vakolantie 55 03400 Vihti, FINLAND
2000/14/CE	Examen CE de type	
2000/14/EG	Baumusterprüfung	

	220	225
Sound Power Level (guaranteed) / Niveau de puissance acoustique (garanti) / Schalleistungspegel (garantiert)	101 dB(A)	101 dB(A)
Sound Power Level (measured) / Niveau de puissance acoustique (mesuré) / Schalleistungspegel (gemessen)	100 dB(A)	100 dB(A)



\_\_\_\_\_ Ylöjärvi, Finland  
Risto Käkälä,  
Managing Director / Directeur général / Geschäftsführer



## Index

---

### A

- Adjust pressure of hydraulic system - 71
- Air filter element - 73
- Attachment control switch pack (optional extra) - 34, 37
- Auxiliary hydraulics oil flow - 31, 37

### B

- Battery check - 69
- Battery disconnect switch - 38

### C

- CAB L (optional extra) - 42
- Cab Safety - 42
- Change engine oil - 73
- Change engine oil filter - 74
- Changing of hydraulic oil filters - 70
- Check / clean engine cooling fan - 75
- Check and tightening of bolts, nuts and fittings - 69
- Check engine oil level - 73
- Check for leaks - 31, 53, 75, 77
- Check fuel lines - 74
- Check pressure of hydraulic system - 71
- Cleaning of the machine - 68
- Control lever of auxiliary hydraulics (hydraulically operated attachments) - 34, 36, 46, 61, 81
- Control lever of boom and bucket - 34, 36
- Control of loader boom, auxiliary hydraulics and other functions - 36
- Controls in the footwell - 34
- Controls of the Loader - 34
- Coupling the attachments - 58
- Coupling the hydraulic hoses of the attachment - 34, 60

### D

- Daily inspections - 45, 55, 66
- Dashboard - 34, 35
- Description of the loader - 19

- Dimensions - 27
- Drive belt - 75
- Drive control - 34, 48
- Drive pedals - 48
- Drive release and anti slip - 48
- Drive speed and pulling force - 27

### E

- Electric 12 V outlet - 34, 39
- Electric system & fuses - 78
- Electric system and handling the battery - 15, 69
- Engine - 28
- Engine compartment - 38
- Engine heater (option) - 39
- Engine maintenance - 73
- Engine Malfunction indicator light (225 / 225LPG only) - 35, 78
- Engine oil cooler - 74
- Engine oil requirements - 31
- Engine service - 73
- Extra work light kit (option) - 41

### F

- Filling of gas bottle - 18
- Filters - list of filters - 75
- Foreword - 3
- Fuel filters - 74
- Fuel requirements - 28, 30
- Fuel system, 225LPG - 77
- Fuel system, gasoline 220/225 - 76

### G

- Gas hose fittings - 31
- Gasoline requirements (220/225) - 30
- General safety instructions - 10
- General specifications - 28
- Greasing of the machine - 68

### H

- Hand throttle lever - 34, 37
- Handling fuel (220/225) - 16
- Handling of heavy loads - 51
- Handling of LPG bottles - 17
- Headlight, beacon, blinker & reflector kit (option) - 41
- Height and Width - 27

- Hydraulic oil change - 70
- Hydraulic oil cooler fan fuse - 35, 79
- Hydraulic oil level - 34, 70
- Hydraulic oil type - 70

### I

- Ignition key - 45
- In an event of a gas leak - 18
- In case the machine tips over - 50
- Indicator lights - 35
- Installing of service support and frame lock - 65
- Intended use - 6
- Introduction - 3

### J

- Joystick - 6 function (optional extra) - 37
- Jump start and auxiliary power - 79

### L

- Lifting - 11, 54
- Light bulbs - 79
- Light control switch (road traffic light kit) - 41
- Lights - 41
- Load diagram - 32
- Loader maintenance - 68
- LPG Fuel - Safety (225LPG) - 17
- LPG gas requirements (225LPG) - 17, 20, 28, 30, 49, 53
- LPG in cold environment - 49
- LPG system maintenance - 77

### M

- Main parts of the loader - 4, 20
- Main switch - 38
- Maintenance schedule - 67
- Make sure all relevant manuals are available - 5, 66
- Material handling - 51
- Metal structures of the loader - 79
- Modifications - 14

### N

- Notes - 83

**O**

Open/close LPG bottle - 45  
Operating instructions - 43  
Operation on uneven surfaces,  
gradients, and near  
excavations - 13  
Operator qualification - 7

**P**

Parking brake lever - 34  
Personal safety and protective  
equipment - 13

**R**

Rated operating capacity - 33  
Rear auxiliary hydraulics  
coupling - 39, 62  
Rear auxiliary hydraulics outlet  
(option) - 34, 39  
Refuelling (220/225) - 52  
Releasing the residual  
pressure of hydraulic  
systems - 62  
Replacing a gas bottle  
(225LPG) - 53  
Requirements for attachments  
- 57  
Reverse buzzer (option) - 39  
Run the LPG system empty -  
47

**S**

Safe operating instructions  
label - 25, 44  
Safe stopping procedure - 46  
Safety First - 10  
Safety frame (ROPS) and  
safety canopy (FOPS) - 14  
Safety instructions - 63  
Safety of LPG systems - 17  
Seat - Seat belt and seat  
adjustments - 40  
Seat adjustments - 40  
Seat heater - 34, 40  
Service and maintenance - 11,  
63  
Services made - 82  
Signs and decals - 21  
Spark arrestor (option) - 39  
Standard seat - 40  
Starting the engine - 45  
Steering of the machine - 50

Stopping the engine (Safe  
stopping procedure) - 46, 51  
Storage - 55  
Storage of LPG gas - 17, 18,  
55  
Suspension seat (option) - 40

**T**

Technical specifications - 27  
Terms used in this manual - 4  
This manual is available in  
other languages as well - 4  
Tie down points - 54  
Tipping load - 32  
To start the engine: - 34, 46  
Towing (retrieval of the  
machine) - 54  
Trailer coupling - 38  
Transporting instructions and  
tie down points - 54  
Troubleshoot - 46, 80  
Tyre pressure check - 69  
Tyres - 29

**U**

Using the auxiliary hydraulics -  
61

**W**

Warning beacon (option) - 41  
Warranty - 8  
Wheel spacers - 29  
Wheel weights (optional extra)  
- 29  
When you want to have a high  
pulling force: - 48  
Windscreen washer and wiper  
- 42  
Work lights - 41  
Working near powerlines - 16  
Working with attachments - 57



# **AVANT<sup>®</sup>**

**Avant Tecno Oy**

**Ylötie 1**

**FIN-33470 YLÖJÄRVI, FINLAND**

**Tel. +358 3 347 8800**

**e-mail: [sales@avanttecno.com](mailto:sales@avanttecno.com)**

AVANT has a policy of continuous development, and retains the right to change specifications without notice. © 2016 Avant Tecno Oy. All rights reserved.

**[www.avanttecnousa.com](http://www.avanttecnousa.com)**